

# **INSTALLATION INSTRUCTIONS**

## **MSD Digital 6M-3L Marine Ignition PN 6564**

**ONLINE PRODUCT REGISTRATION:** Register your MSD product online. Registering your product will help if there is ever a warranty issue with your product and helps the MSD R&D team create new products that you ask for! Go to [www.msperformance.com/registration](http://www.msperformance.com/registration).

### **Parts Included:**

1 – MSD Marine Ignition	1 – Engine Harness
1 – Harness, Mag Cable	1 – Parts Bag

**WARNING:** During installation, disconnect the battery cables. When disconnecting, always remove the negative cable first and install it last.

### **OPERATION AND FEATURES**

The Digital 6M-3L Marine Ignition is an advanced ignition packed with legendary MSD Ignition power, and offers a slew of features:

- Up to 150 millijoules energy when used with MSD 8250 HVC coil. Otherwise, 135 millijoules.
- 0, 10, and 20 degrees start retard
- Easy to read LED display.
- Resettable Maximum Engine Speed indicator.
- Rev Limiter, 4, 6, or 8 Cylinder Select and Start retard settings and readout.
- Battery Voltage and Engine Speed readouts.
- Intuitive setup with three easily accessible rotary dials.
- Fully potted electronics to withstand the demanding marine environment.
- Sealed connector for clean wiring and trouble-free operation.
- Smooth Rev Limiter.
- Highly efficient, minimal power consumption to minimize battery draw.
- Easy starting down to 6 volts.
- Shift Interrupt eases shifting effort.

**Note:** Solid core spark plug wires cannot be used with an MSD Ignition Control.

**Note:** Do not use digital or dial-back timing lights.

### **CAPACITIVE DISCHARGE**

The Digital 6M-3L Marine Ignition features a capacitive discharge ignition design. The majority of stock ignition systems are inductive ignitions. In an inductive ignition, the coil must store and step up the voltage to maximum strength in between each firing. At higher RPM, since there is less time to charge the coil to full capacity, the voltage falls short of reaching maximum energy which results in a loss of power or top end miss.

The MSD Ignition features a capacitor which is quickly charged with 520 - 550 volts and stores it until the ignition is triggered. With the CD design, the voltage sent to the coil positive terminal is always at full power even at high RPM.

### **MULTIPLE SPARKS**

The MSD produces high power multiple sparks for each firing of a plug. The number of multiple sparks that occur decreases as RPM increases; however, the spark series always lasts for 20° of crankshaft rotation. Above 3,300 RPM there is not enough “time” to fire the spark plug more than

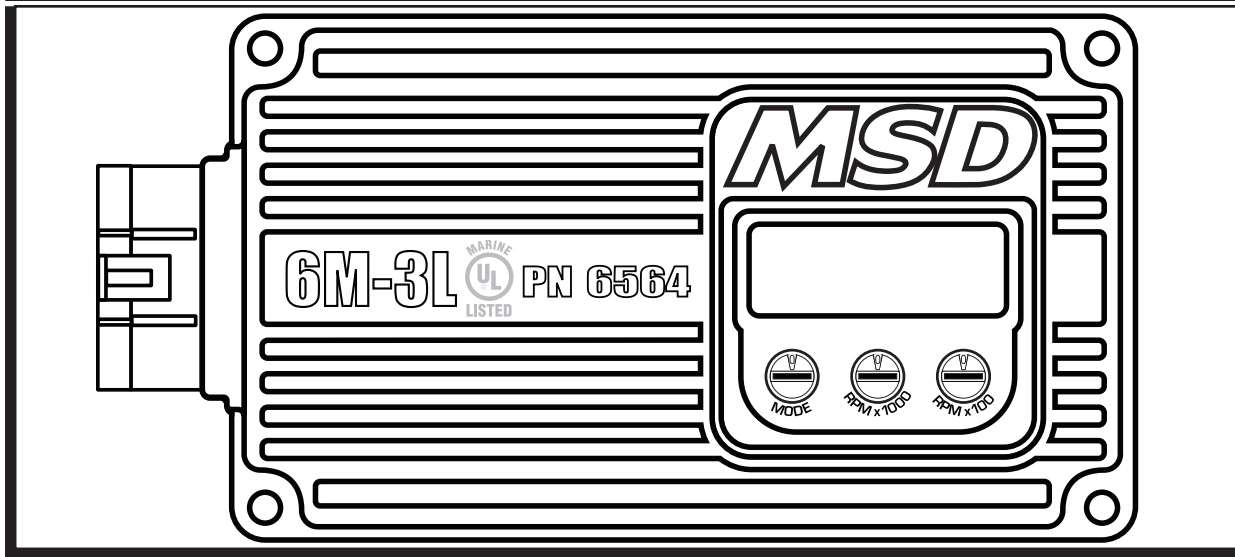


Figure 1 Marine Ignition Controller, PN 6564

## GENERAL INFORMATION

### BATTERY

The Digital 6M-3L Marine Ignition will operate on any negative ground, 12 volt electrical system with a distributor. The unit can be used with 16 volt batteries and can withstand a momentary 20 volts in case of jump starts. The ignition will deliver full output with a supply of 6 - 18 volts. If your application does not use an alternator, allow at least 12 amp/hour for every half hour of operation. The MSD uses about .9 amps for every 1,000 RPM. If the same battery is used to crank the engine and power other accessories, such as an electric fuel or water pump, the battery amp/hour rating should be increased beyond the 12 amp-hour recommendation.

### COILS

The Digital 6M-3L Marine Ignition can be used with most stock coils and aftermarket coils designed as replacements. For maximum ignition power of 150 millijoules at high RPM race applications, MSD recommends the HVC Power Coil PN 8250. When another coil is used, 135 millijoules is applied to the ignition coil. The Blaster HVC PN 8252, Blaster HVC II PN 8253, are recommended for less demanding racing applications. Remove any or all ballast resistors in the system.

### TACHOMETERS

The Digital 6M-3L Marine Ignition features a gray tach output wire that provides a trigger signal for tachometers, a shift light or other RPM activated devices. The Tach Output wire produces a 12 volt square wave signal with a 20% duty cycle.

Some boats with factory tachometers may require a Tach Adapter to operate with the MSD. For more information on tachometers and MSD Tach Adapters, see the tachometer section on page 7. If your boat has an in-line filter it may cause the tach to drop to zero on acceleration. If this occurs, bypass the filter.

### SPARK PLUGS AND WIRES

Spark plug wires are very important to the proper operation of your ignition system. A good quality, helically wound wire and proper routing are required to get the best performance from your ignition, such as the MSD 8.5mm Super Conductor Wire. Helically wound wires provide a good path for the spark to follow while keeping Electro Magnetic Interference (EMI) to a minimum. Excessive EMI, such as the amount that solid core wires produce, will interfere with the operation of the MSD. **Solid core spark plug wires cannot be used with an MSD Ignition.**

**Routing:** Correct routing of the plug wires is also important to performance. Wires should be routed away from sharp edges and engine heat sources. If there are two wires that are next to each other in the engine's firing order, the wires should be routed away from each other to avoid inducing a spark into the other wire. For example, in a Chevy V8, the firing order is 1-8-4-3-6-5-7-2. The #5 and #7 cylinders are next to each other in the engine and in the firing order. If the voltage from the #5 wire is induced into #7 detonation could occur and cause engine damage. To add more heat protection to your plug wires, MSD offers Pro-Heat Guard, PN 3411. This is a glass woven and silicone coated protective sleeve that slides over your plug wires. For extra protection of the spark plug boots, MSD offers Pro Boot Guard, PN 3412.

**Spark Plugs:** Choosing the correct spark plug design and heat range is important for getting the best performance possible. Since there are so many engine combinations and manufacturers, MSD does not recommend which plug or gap is exactly right for your application. It is recommended to follow the engine builder or manufacturer's specification for spark plugs. The gap of the plugs can be opened in 0.005" increments, then tested until the best performance is obtained. MSD judges the plug gap by compression and components.

These examples are just starting points to get you going in the right direction. Every application is different and should be tested and tuned.

Compression	Spark Plug Gap
Up to 10.5:1:	0.050" - 0.060"
10.5:1 - 13.0:1:	0.040" - 0.050"
Above 13.0:1:	0.035" - 0.045"

**Welding:** If you are welding on your boat, to avoid the chance of damage, always disconnect both Heavy Power cables of the MSD (Disconnecting the tach and ignition wire is also recommended).

**Distributor Cap and Rotor:** It is recommended to install a new distributor cap and rotor when installing the MSD Ignition Control. The cap should be clean inside and out especially the terminals and rotor tip. On boats with smaller caps, it is possible for the air inside the cap to become electrically charged causing crossfire, which can result in misfire. This can be prevented by drilling a couple vent holes in the cap. The holes should be placed between the terminals, at rotor height and face away from the intake. If your environment demands it, place a small piece of screen over the hole to act as a filter.

**MOUNTING**

The MSD can be mounted in the engine compartment as long as it is away from direct engine heat sources. It is not recommended to mount the unit in an enclosed area such as the glove box. When you find a suitable location to mount the unit, make sure the wires of the ignition reach their connections. Also be sure that the program dials can be accessed. Hold the Ignition in place and mark the location of the mounting holes. Use a 3/16" bit to drill the mounting holes. Next, install the vibration mounts and mount the ignition.

## WIRING

The Digital 6M-3L Marine Ignition uses a main wiring harness that connects to the ignition through a sealed and locked connection.

<b>Power Leads</b>	These are the two heavy 12 gauge wires and are responsible for getting direct battery voltage to the ignition. The ignition is protected from reverse polarity connections.
<b>Heavy Red</b>	This wire connects directly to the battery positive (+) terminal or a positive battery junction such as the starter solenoid. Note: Do not connect to the alternator.
<b>Heavy Black</b>	This wire connects to a good ground, either at the battery negative (-) terminal or to the engine.
Red	This wire is responsible for turning the MSD On and Off. Connects to a switched 12 volt source such as the ignition key or switch. (Max Key On / Engine Off current draw of 50 mA due to LED display.)
Orange	This wire connects to the coil positive (+) terminal. This is the ONLY wire that makes electrical contact with the positive coil terminal.
Black	This wire connects to the coil negative (-) terminal. This is the ONLY wire that makes electrical contact with the negative coil terminal.
<b>Trigger Wires</b>	There are two circuits that can be used to trigger the MSD Ignition; a Points circuit (the White wire) and a Magnetic Pickup circuit (the Green and Violet wires). Only one circuit will be used at a time.
White	This wire is used to connect to points, an electronic ignition amplifier output, or to the Yellow wire of an MSD Timing Accessory. When this wire is used, the Magnetic Pickup connector is not used.
Violet and Green (Magnetic Pickup Connector)	These wires are routed together in one harness as the magnetic pickup connector. The connector plugs directly into an MSD marine distributor. It will also connect to aftermarket pickups. The Violet wire is positive (+) and the Green wire is negative (-). When these wires are used, the White wire is not. This harness comes with a sealed weather pack 2-pin connector.
<b>Accessory Wire</b>	
Gray	Tach output wire. Connects to the tachometer trigger wire or other RPM activated device.

## GENERAL WIRING INFORMATION

**Wire Length:** All of the wires of the MSD Ignition may be shortened as long as quality connectors are used or soldered in place. To lengthen the wires, use one size bigger gauge wire (10 gauge for the power leads and 16 gauge for the other wires) with the proper connections. All connections must be soldered and sealed.

**Grounds:** A poor ground connection can cause many frustrating problems. When a wire is specified to go to ground, it should be connected to the battery negative terminal, engine block or chassis. There should always be a ground strap between the engine and the chassis. Always securely connect the ground wire to a clean, paint free, metal surface.

**Ballast Resistor:** If your boat has a ballast resistor in-line with the coil wiring, it is recommended to bypass it.

**Routing Wires:** The MSD wires should be routed away from direct heat sources such as exhaust manifolds and headers and any sharp edges. The trigger wires should be routed separate from the other wires and spark plug wires. It is best if they are routed along a ground plane such as the block or firewall which creates an electrical shield. The magnetic pickup wires should always be routed separately and should be twisted together to help reduce EMI.

### PROTECTION

The Digital 6M-3L Marine Ignition has a built in reverse polarity protection circuit. This will protect the ignition in the event of reversed battery connections.

## PROGRAMMING

The Digital 6 Off-Road Ignition is programmable with the three rotary switches and LED digital display on the face of the unit. Below are the details on how to program your unit.

### LED DIGITAL DISPLAY

The LED Display will show;

- Maximum Engine RPM Reached
- Cylinder Select and Start Retard
- 8 Cyl w/ 0°, 10° or 20° start retard
- 6 Cyl w/ 0°, 10° or 20° start retard
- 4 Cyl w/ 0°, 10° start retard
- Rev Limit Setting
- Live Tachometer
- Battery Voltage

These can be set with the rotary switch marked **Mode**.  
(Figure 2)

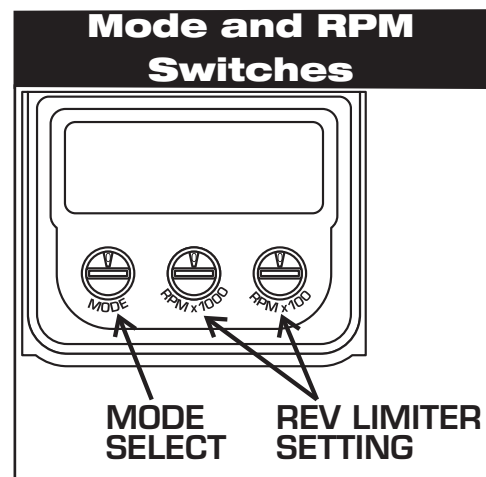


Figure 2 Mode and RPM Switches

### SHIFT ASSIST FEATURE

This feature is activated by the ESA (Electronic Shift Assist System) which helps ease the shifting effort and smooths the operation by reducing load when shifting from forward to reverse.

1. Disconnect the ESA module wire from the negative side of the coil.
2. Connect it to the MSD points white wire or MAG Violet wire (whichever is not in use)

## REV LIMITER

The Digital 6M-3L Marine Ignition features a built-in Soft Touch Rev Control that can be set from 2,000 to 11,900 RPM. It provides smooth and accurate rev limiting by dropping spark to individual cylinders. The Soft Touch produces a load-free rev limit that varies less than 5% from the selected RPM. The RPM limit is adjusted in 1000 and 100 RPM increments with the sealed rotary switches marked RPM x 1000, and RPM x 100. For example: to set a rev limit of 7,500 RPM the dial marked RPM x 1000 would be set to number 7, and the dial marked RPM x 100 would be set to 5. Once set the LED display will read 7500.

For a rev limiter in the 10,000 range, set the dials as they would be for any other RPM but the left dial will use '0'. To set the rev limiter to 11,000 RPM, put the left dial to '1' and the right dial to '0'. (See Figure 2)

**Note:** The engine can be running as you make adjustments to the rev limiter function.

## CYLINDER SELECT

The Digital 6M-3L Marine Ignition is programmed at the factory for use on 8-cylinder engines. If you are installing on a 4 or 6 cylinder engine, you will have to program the ignition. This is easily achieved through the rotary switch marked **Mode**. Below is a chart that indicates the programming position of the rotary switch. The **Mode** switch will also set a start retard, display a live tach or display battery voltage.

### MODE SWITCH SELECTION CHART

Mode Switch Position	Order of Display and Function Max Engine RPM / Number of Cylinders Selected / Start Retard Selected / Rev Limit
0	*Live Tachometer / For testing only
1	Max Engine RPM / 8 Cyl, 0° Start Retard / Rev Limit Set
2	Max Engine RPM / 8 Cyl, 10° Start Retard / Rev Limit Set
3	Max Engine RPM / 8 Cyl, 20° Start Retard / Rev Limit Set
4	Max Engine RPM / 6 Cyl, 0° Start Retard / Rev Limit Set
5	Max Engine RPM / 6 Cyl, 10° Start Retard / Rev Limit Set
6	Max Engine RPM / 6 Cyl, 20° Start Retard / Rev Limit Set
7	Max Engine RPM / 4 Cyl, 0° Start Retard / Rev Limit Set
8	Max Engine RPM / 4 Cyl, 10° Start Retard / Rev Limit Set
9	*Battery Voltage / For testing only

\*When the **Mode** switch is set to 0 or 9, the unit defaults to 8 cylinder, 0° start retard operation. Position 0 and 9 are designed as tools. When the switch is set to 0 the LED display reads the current RPM of the engine as a **live tach**. Position 9 on the Mode switch will display the **battery supply voltage** to the ignition.

When the **Mode** switch is set to positions 1-8, the unit will be set to the corresponding setting in the above **Mode Switch Selection Chart**.



**POWER UP SEQUENCE**

The Digital 6M-3L Marine Ignition executes a “Power Up Sequence” each time ignition power is cycled off and on. During this sequence the LED display will provide important information in the following order:

1. The maximum RPM limit the engine reached for the last 20 minutes of runtime.  
\*See Note below.
2. Cylinder selected (4,6, or 8) and Start Retard (0°, 10°, or 20°)
3. Rev Limiter Setting

**\*Note:** The Digital 6M-3L Marine will retain the maximum RPM reached for the last 20 minutes of engine runtime. This can only be reset by powering up the ignition for 20 minutes continuously. After reset, the high RPM will read 0 when powered up.

**PRESTART CHECK LIST**

- The only wires connected to the coil terminals are the MSD **Orange** to coil positive and **Black** to coil negative.
- The small **Red** wire of the MSD is connected to a switched 12 volt source.
- The MSD power leads are connected directly to the battery positive and negative terminals.
- The battery is connected and fully charged if not using an alternator.
- The engine is equipped with at least one ground strap to the chassis.
- If installing on a 4 or 6-cylinder engine, confirm the **Mode** switch is set to the correct number setting as outlined in the Mode Switch Selection Chart on page 6.

**TROUBLESHOOTING**

Every MSD Ignition undergoes numerous quality control checks including a four hour burn-in test. If you experience a problem with your MSD, our research has shown that the majority of problems are due to improper installation or poor connections. The Troubleshooting section has several checks and tests you can perform to ensure proper installation and operation of the MSD. If you have any questions concerning your MSD, call our Customer Support Department at (915) 855-7123, 7 PM - 5 PM mountain time (Closed for lunch 12 PM-1 PM).

**TACH/FUEL ADAPTERS**

If your tachometer does not operate correctly or if you experience a no-run situation with your foreign boat, you probably need an MSD Tach Adapter. The chart in Figure 3 lists common tachometers and if an adapter is necessary.

<b>Tachometer Compatibility List</b>		
<b>AFTERMARKET TACHOMETER</b>	<b>WHITE WIRE TRIGGER</b>	<b>MAGNETIC TRIGGER CONNECTOR</b>
AUTOGAGE	8910	8920
AUTOMETER	NONE	NONE
FORD MOTORSPORTS	NONE	NONE
MALLORY	NONE	NONE
MOROSO	NONE	NONE
STEWART (voltage triggered)	8910	8920
S.W. & BI TORX	NONE	NONE
SUN	8910	8920
VDO	NONE	NONE
AMC (JEEP)	8910	8920
CHRYSLER	8910	8920
FORD (voltage triggered)	8910	8920
GENERAL MOTORS	Bypass In-Line Filter	Bypass In-line filter
IMPORTS	8910	8920

Note: On the list above, the trigger wire on tachometers that are marked NONE may be connected to the Gray Tach Output Wire on the MSD 6AL Ignition.

**Figure 3 Common Tachometers and Adapters.**

## ENGINE RUN-ON

If your engine continues to run even when the ignition is turned Off you are experiencing engine Run-On. This usually only occurs on older boats with an external voltage regulator. Because the MSD receives power directly from the battery, it does not require much current to keep the unit energized. If you are experiencing run-on, it is due to a small amount of voltage going through the charging lamp indicator and feeding the small Red wire even if the key is turned off.

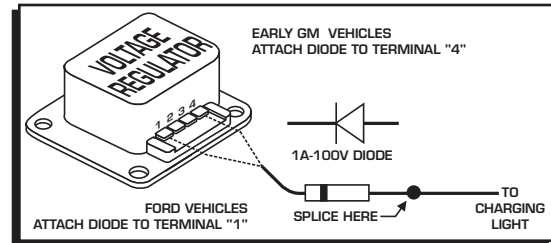


Figure 4 Installing the diode to a GM or Ford Engines.

**Early Ford and GM:** To solve the Run-On problem, a Diode is supplied with the MSD in the parts bag. By installing this Diode in-line of the wire that goes to the Charging indicator, the voltage is kept from entering the MSD. Figure 4 shows the proper installation for early Ford and GM engines.

**Note:** Diodes are used to allow voltage to flow only one way. Make sure the Diode is installed facing the proper direction (as shown in Figure 4).

**Ford:** Install the Diode in-line to the wire going to the "1" terminal.

**GM:** Install the Diode in-line to the wire going to terminal #4.

**GM:** 1973 - 1983 with Delcotron Alternators.

**GM:** Delcotron Alternators use an internal voltage regulator. Install the Diode in-line on the smallest wire exiting the alternator (Figure 5). It is usually a Brown wire.

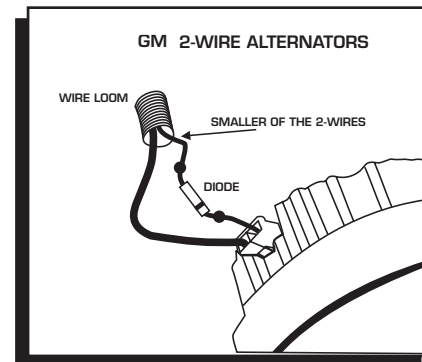


Figure 5 Installing the Diode to a 1973-1983 GM Engines.

## MISSES AND INTERMITTENT PROBLEMS

**Most other applications:** On other applications where engine Run-On is experienced, a Resistor can be put in-line to the MSD's small Red wire (Figure 6). This resistor will keep voltage from leaking through to the MSD unit.

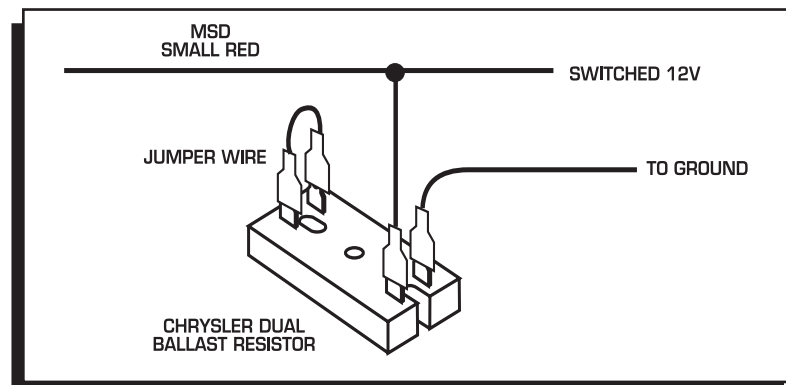


Figure 6 Wiring the Dual Ballast Resistor for Run-On.

Experience at the races has shown that if your engine is experiencing a miss or hesitation at higher RPM, it is usually not directly ignition. Most probable causes include faulty wiring, a coil or plug wire failure, arcing from the cap or boot plug to ground or spark ionization inside the cap. Several items to inspect are:

- Always inspect the plug wires at the cap and at the plug for a tight connection and visually inspect for cuts, abrasions or burns.
- Inspect the Primary Coil Wire connections. Because the MSD is a Capacitive Discharge ignition and it receives a direct 12 volt source from the battery, there will not be any voltage at the Coil Positive (+) terminal even with the key turned On. During cranking or while the engine is running, very high voltage will be present and no test equipment should be connected.



**WARNING:** Do not touch the coil terminals during cranking or while the engine is running.

- Make sure that the battery is fully charged and the connections are clean and tight. If you are not running an alternator this is an imperative check. If the battery voltage falls below 9 volts during a race, the MSD output voltage will drop and the current draw will increase.
- Is the engine running lean? Inspect the spark plugs and complete fuel system.
- Inspect all wiring connections for corrosion or damage. Remember to always use proper connections followed by soldering and seal the connections completely.

If everything checks positive, use the following procedure to test the ignition for spark. MSD also offers an Ignition Tester, PN 8998 or PN 8996. This tool allows you to check your complete ignition system while it is in the car as well as the operation of RPM limits, activated switches and shift lights.

**CHECKING FOR SPARK**

**If triggering the ignition with the White wire:**

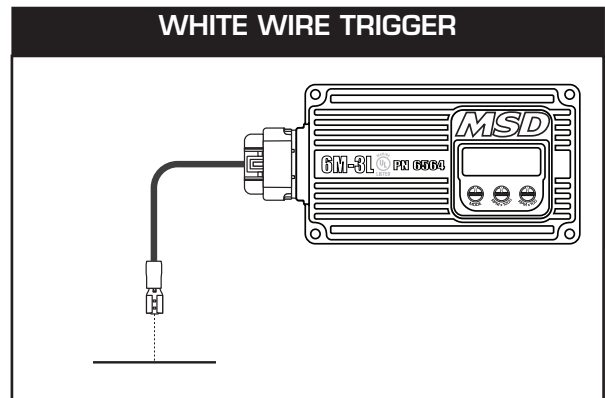
1. Make sure the ignition switch is in the "Off" position.
2. Remove the coil wire from the distributor cap and set the terminal approximately 1/2" from ground.
3. Disconnect the MSD White trigger wire from the distributor.
4. Turn the ignition to the On position. Do not crank the engine.
5. Tap the White wire to ground several times (See Figure 7) . Each time you pull the wire from ground, a spark should jump from the coil wire to ground. If spark is present, the ignition is working properly. If there is no spark skip to step 6.

**If triggering with the Magnetic Pickup:**

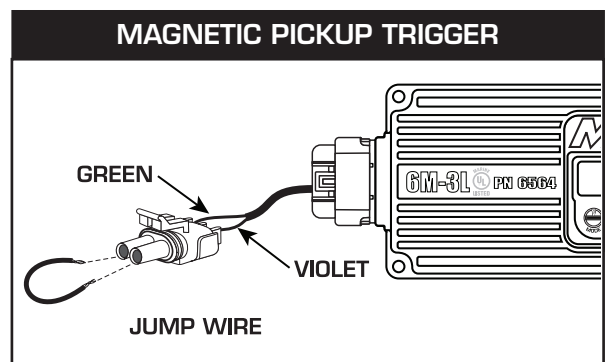
1. Make sure the ignition switch is in the "Off" position.
2. Remove the coil wire from the distributor cap and set the terminal approximately 1/2" from ground.
3. Disconnect the MSD magnetic pickup wires from the distributor.
4. Turn the ignition to the On position. Do not crank the engine.
5. With a small jumper wire, short the MSD's Green and Violet magnetic pickup wires together several times (See Figure 8). Each time you break this short, a spark should jump from the coil wire to ground. If spark is present, the ignition is working properly. If there is no spark skip to step 6.

**6. If there is no spark:**

- A. Inspect all of the wiring.
- B. Substitute another coil and repeat the test. If there is now spark, the coil is at fault.
- C. If there is still no spark, check to make sure there are 12 volts on the small Red wire from the MSD when the key is in the On position. If 12 volts are not present, find another switched 12 volt source and repeat the test.
- D. If, after following the test procedures and inspecting all of the wiring, there is still no spark, the MSD Ignition is in need of repair. See the Warranty and Service section for information.

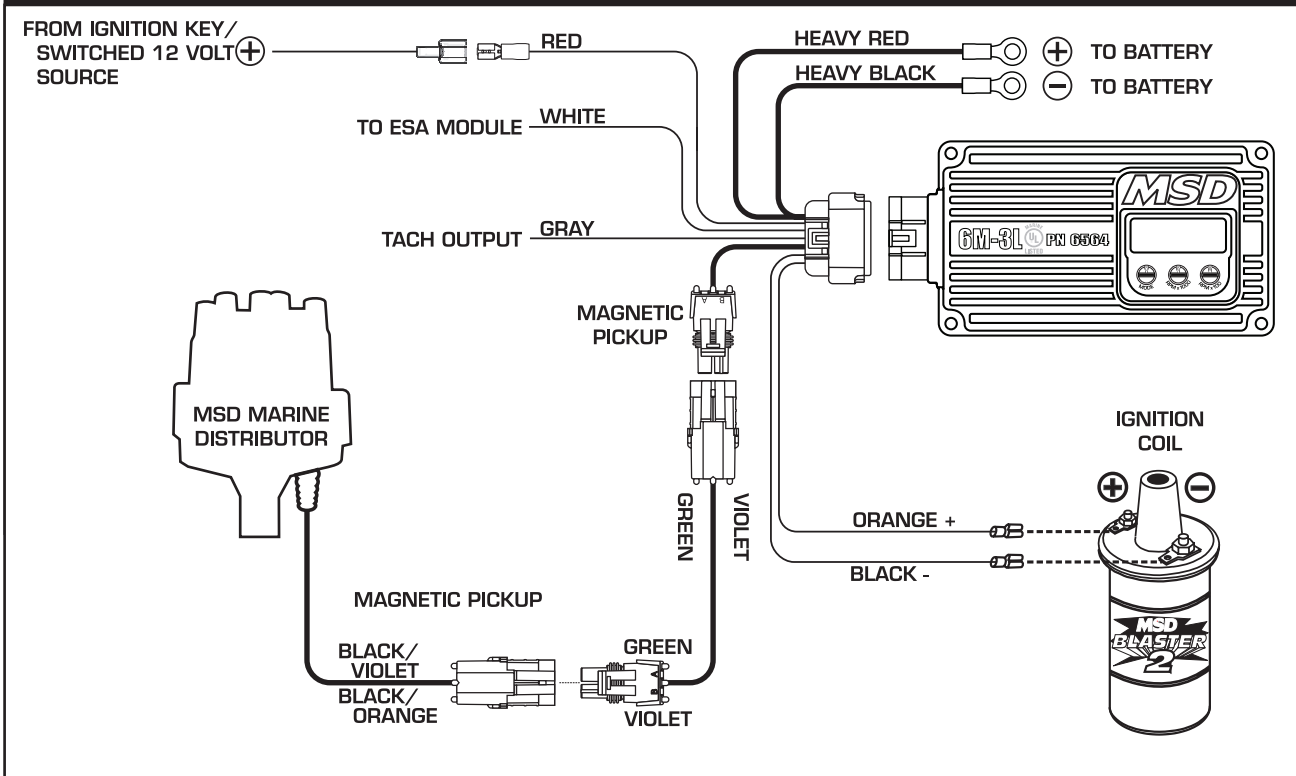


**Figure 7 Checking for Spark with the White Wire.**

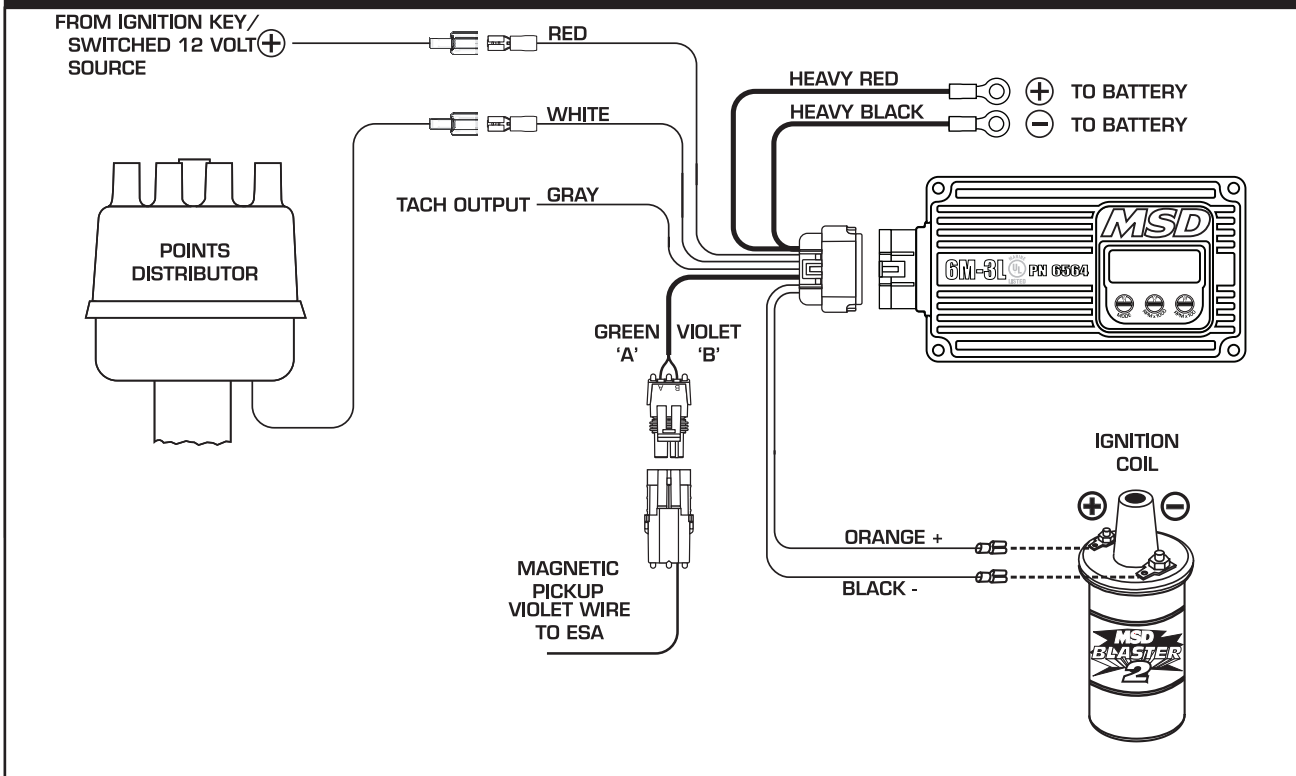


**Figure 8 Checking for Spark with the Mag Pickup.**

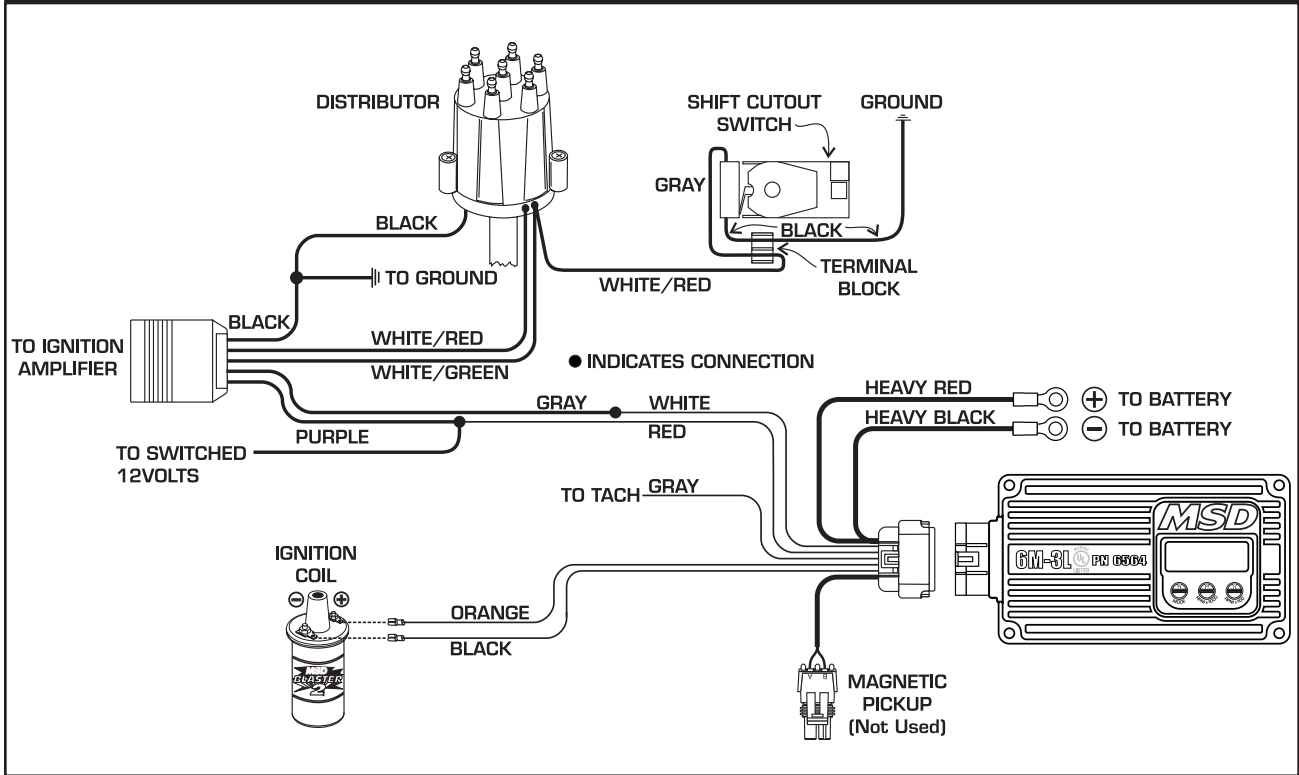
**MSD SYSTEMS Digital 6M-3L Marine Ignition PN 6564 Magnetic Pick-up installation.**



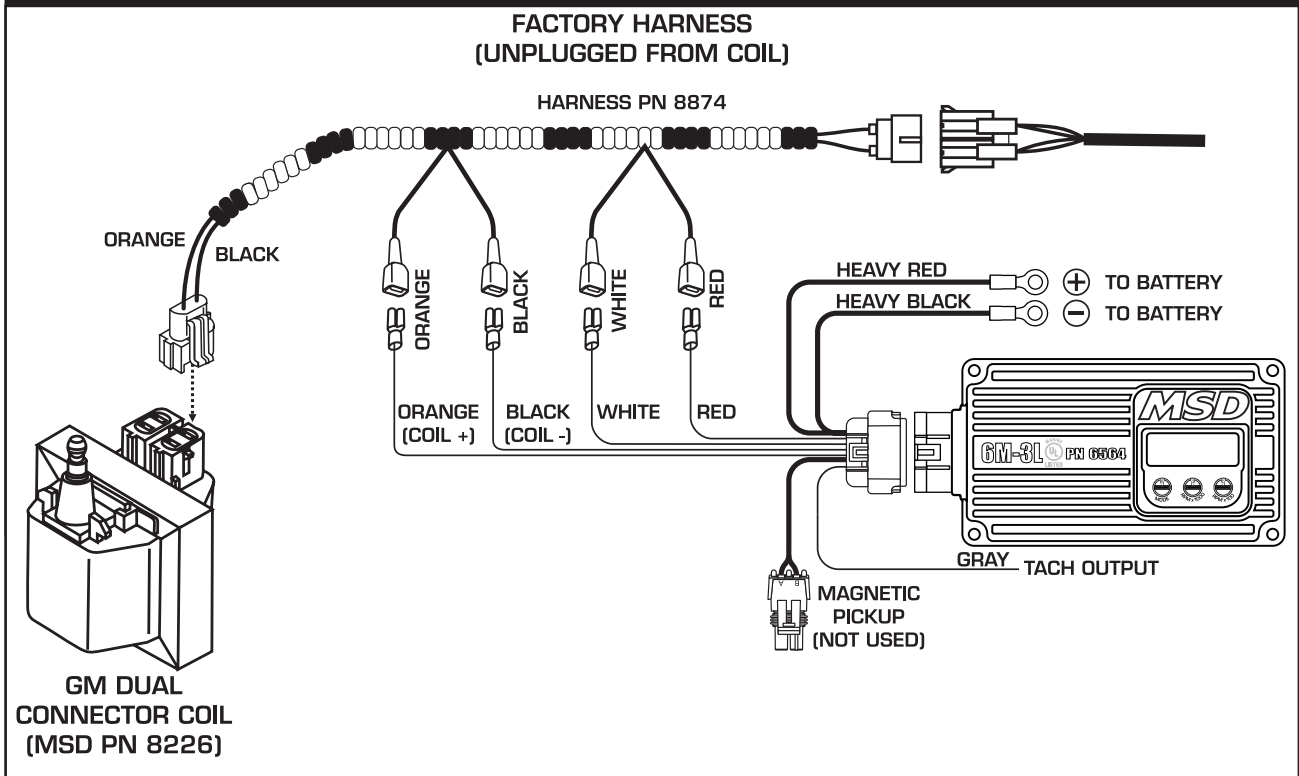
**MSD SYSTEMS Digital 6M-3L Marine Ignition PN 6564 Points installation.**



**MSD SYSTEMS Digital 6M-3L Marine Ignition to Mercruiser Electronic Ignition**



**MSD SYSTEMS Digital 6M-3L Marine Ignition to GM Dual Connector Coil**



If you experience difficulties when installing your MSD, contact our Customer Support Department at (915) 855-7123 (7 - 5 Mountain time) or e-mail us at: [msdforms@msdperformance.com](mailto:msdforms@msdperformance.com)

