

# OWNER'S MANUAL

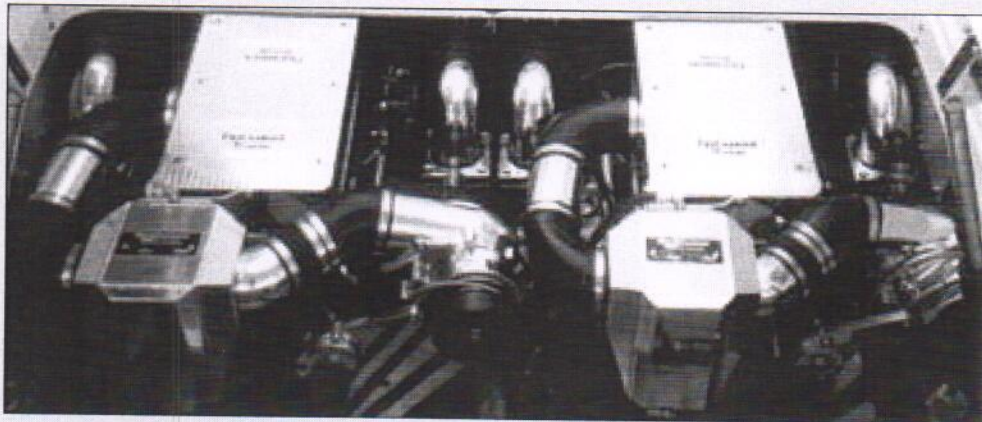
## MERC/CHEVY CARBURETED BIG BLOCK

### M-4 INTERCOOLED SYSTEM

# PROCHARGER<sup>®</sup>

*Marine*

*Centrifugal Supercharger Systems*



*The Intercooled Supercharging Experts!<sup>®</sup>*



ACCESSIBLE TECHNOLOGIES, INC.  
© 2006 ATI, ALL RIGHTS RESERVED  
1MA323







## INSTALLATION OVERVIEW

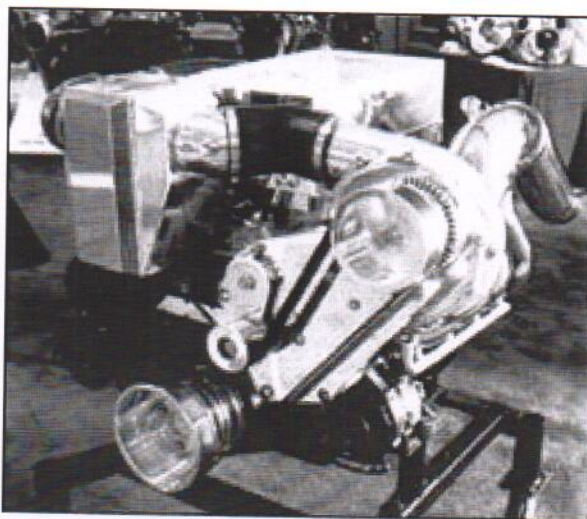
Congratulations on the purchase of your ProCharger® centrifugal supercharger system, and welcome to the world of centrifugal supercharging. You are now an owner of the most powerful, reliable, and most technologically advanced supercharger system available!

This Owner's Manual contains the following sections:

- **INTRODUCTION**
- **INSTALLATION INSTRUCTIONS**
- **OPERATION AND MAINTENANCE**
- **WARRANTY**



If you are performing the installation of this system and this is your first ProCharger installation, you may benefit from reading the installation instructions prior to proceeding, reviewing each section as you go. If you are familiar with supercharging, remember that centrifugal supercharging differs from roots supercharging, and the same rules do not necessarily apply. This is primarily due to the ProCharger's unmatched adiabatic and mechanical efficiency as well as the reduced charge air temperatures that result from intercooling.

- A. PREPARATION**
- B. OIL DRAIN SETUP**
- C. OIL FEED SETUP**
- D. ENGINE ACCESSORY AND PROCHARGER INSTALLATION**
- E. CARBURETOR ENCLOSURE INSTALLATION AND BOOST-REFERENCED FUEL DELIVERY**
- F. AIR INLET ( AND OPTIONAL INTERCOOLER TUBING ) INSTALLATION**
- G. WATER LINE INSTALLATION**
- H. FUEL SYSTEM UPGRADES**
- I. INSTALLATION REVIEW AND SAFETY CHECK**



## IMPORTANT CONCEPTS FOR RELIABLE OPERATION!

With blow-through carburetion used in ProCharger Marine systems, **it is extremely important that your fuel delivery be boost-referenced.** This simply means that a boost line is run to your fuel system so that fuel pressure is increased by 1 psi for every 1 psi of boost pressure. For example, if your fuel pressure is 7 psi at idle and you run 9 psi of boost pressure without boost referencing, you would have 2 psi of net pressure (9 psi - 7 psi) forcing fuel back into your fuel tank! By running a boost reference line, when boost pressure reaches 9 psi your fuel pressure will now be at 16 psi to ensure proper fuel delivery. In this example, net pressure will still be 7 psi (16 psi - 9 psi), so you have maintained the same net fuel pressure you had at idle. Please refer to section E of the enclosed installation instructions for more information. **Failure to properly boost-reference your fuel delivery can result in severe engine damage!** You should also ensure that you have proper jetting in your carburetor. **Never run a ProCharged motor with stock jets!** Please refer to the tuning section at the end of this manual regarding jetting.

Torque Specification Chart	 <b>Grade 5</b> Torque (lb. ft.)			 <b>Grade 8</b> Torque (lb.ft.)		
	Thread Size	11	8	7	16	12
1/4-20	13	10	8	18	14	11
5/16-18	23	17	14	33	25	20
5/16-24	26	19	15	36	27	22
3/8-16	41	31	25	58	44	35
3/8-24	47	35	28	66	49	39
7/16-14	66	49	40	93	70	56
7/16-20	74	55	44	104	78	62
1/2-13	101	75	60	142	106	85
1/2-20	113	85	68	160	120	96

### PLEASE NOTE:

Due to minor factory changes over several years, this ProCharger system may contain some parts not used on your particular model year. For more information, please refer to the packing list included with your shipment.



## INSTALLATION OVERVIEW

For best results we recommend that you review the installation instructions beforehand, following the installation instructions closely and in sequence. A detailed packing list is provided (inside box) to help you identify the components of your ProCharger Marine system. The following tools will be required to install your ProCharger Marine supercharger system:

### REQUIRED TOOLS & SUPPLIES

- 3/8" SOCKET SET (STANDARD & METRIC)
- 1/2" SOCKET SET (STANDARD & METRIC)
- SCREWDRIVER SET
- OPEN END WRENCH SET (STANDARD & METRIC)
- RAZOR BLADE OR CARPET KNIFE
- ADJUSTABLE WRENCH
- NUT DRIVER SET
- 8 SPARK PLUGS\*\*
- SPARK PLUG SOCKET\*\*
- OIL FILTER
- HEAVY GREASE\*
- SILICONE SEALER\*
- LARGE HAMMER\*
- 3/8" NPT TAP\*
- 9/16" TAPERED PUNCH\*
- CENTER PUNCH\*
- PLIER SET
- WIRE CUTTERS
- OIL FILTER WRENCH
- 5 QUARTS ENGINE OIL

Ideally, the following gauges should also be available to properly verify the performance of the installed system and monitor your craft's performance (especially for high performance applications):

- manifold boost pressure gauge
- fuel pressure gauge (0-15 or 0-25 psi)

Both gauges should be of a type that may be read from the cockpit while performing W.O.T. performance tests. Cockpit-mounted gauges are preferable.

The engine on which the ProCharger is installed should have stock compression. If your engine has been modified in any way, please check with ATI or your dealer before proceeding with the installation. This supercharger system is intended for use on a strong, well maintained engine. Installation on a worn or troublesome engine should be reconsidered. **Accessible Technologies is not responsible for damage to an engine.**

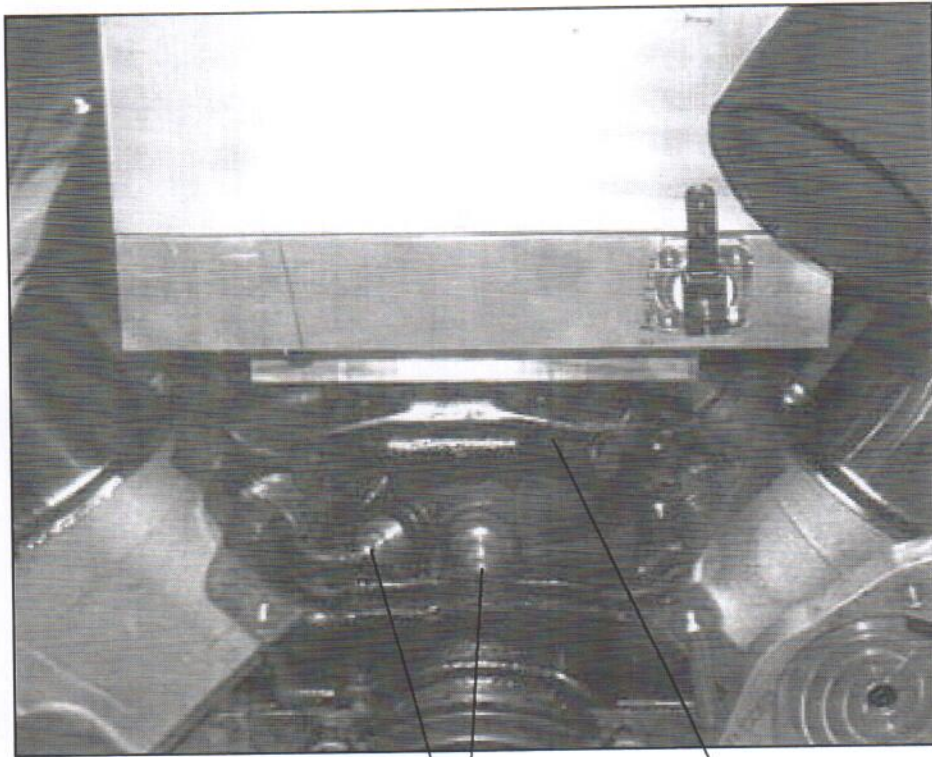


**Warning: Your engine and propeller should be configured so that maximum speed does not exceed boat manufacturer's recommendations for your hull**

\* if oil pan does not already have oil return fitting

\*\*if current plugs have operated more than 100 hours, or are more than 1 yr old

REVISED 01-03-02



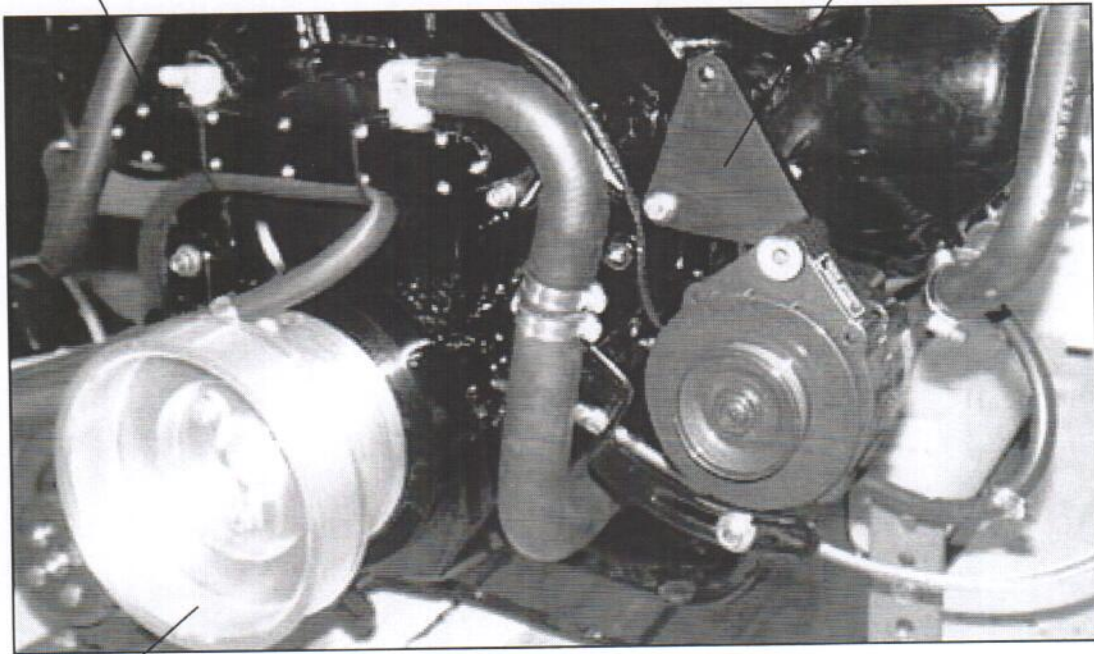
**FIGURE A1**  
**THERMOSTAT HOUSING INSTALLATION**

**THERMOSTAT HOUSING (MERC HP TYPE)**

**1/2" NPT AUXILIARY PORTS**

**CROSSOVER TUBE**

**ALTERNATOR BRACKET**



**ATI CRANK PULLEY**

**FIGURE A2**  
**CROSSOVER TUBE, ALTERNATOR BRACKET DETAIL**



# INSTALLATION INSTRUCTIONS

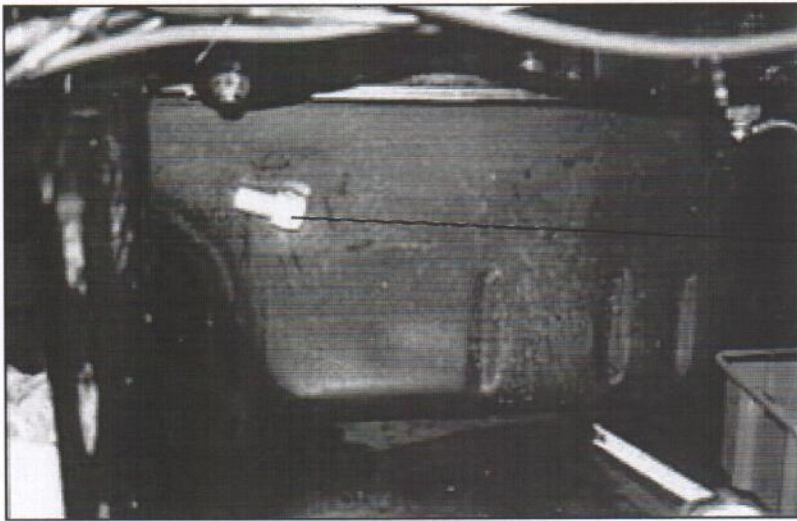
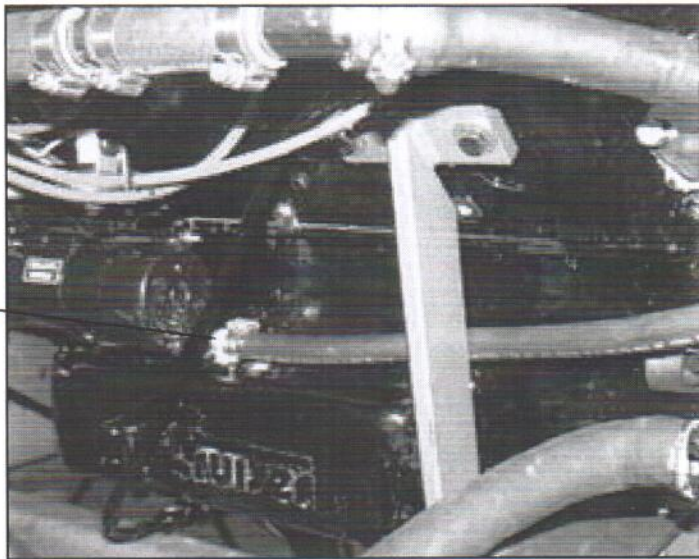
## A. PREPARATION

*Completion of this section will configure engine for installation of the ProCharger system.*

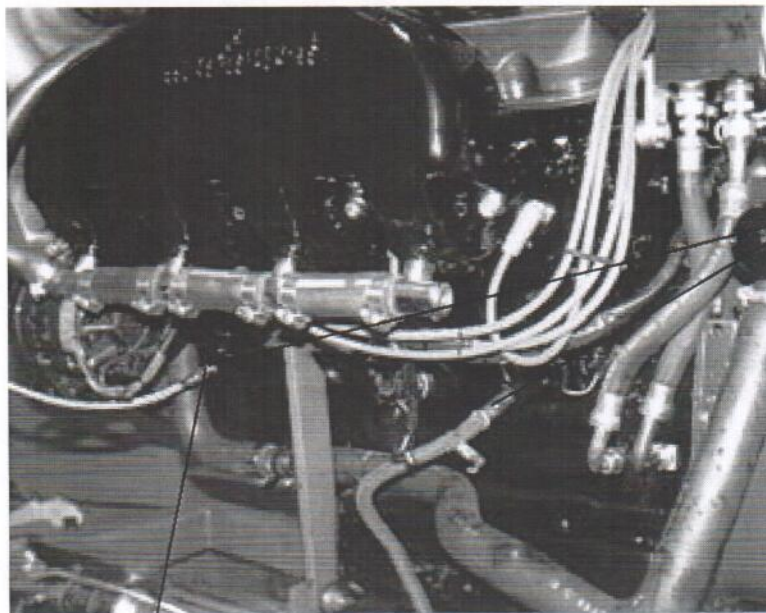
1. Remove the water pump, power steering pump, alternator, associated brackets and crank pulley from the engine (leaving the sea water pump and harmonic balancer installed). If your engine is so equipped, remove the stud threaded into the lowermost hole in the front of the starboard head, feeding through the seawater pump .
2. Remove all water lines connected to the thermostat housing assembly, removing the exhaust Tee fitting & any sensors from the stock housing.
3. Remove the thermostat housing assembly (Merc HP type) from the intake manifold & install on the on the dual 4 bbl manifold (refer to figure A1). There is no need to re-install the factory thermostat. *Note: If your engine is not already equipped with a low profile thermostat housing, one must be purchased. Such a housing should be available through your local Mercruiser dealer.*
4. Due to the extreme high performance nature of this ProCharger kit, there are several unique exhaust combinations available. This being the case, the installer may or may not opt to utilize the 1/2" npt ports available at the front of the intake manifold. However, the two lines from the thermostat housing must be plumbed into the exhaust system to allow heated water to escape the engine's cooling system.
5. Install the supplied crossover tube in place of the water pump using the supplied gaskets and 3/8" x1" bolts & lockwashers. The crossover should be installed with the fittings to the top (refer to figure A2).
6. Using the supplied straight metal connector, clamp the supplied 90°x1 1/4" rubber elbow between the discharge hose of the power steering cooler and the fitting on the crossover tube installed in step 5. (refer to Figure A2)
7. Remove the existing mechanical or electric fuel pump(s) along with any fuel lines between it/ them and the carburetors. Install the supplied fuel pump block-off plate if applicable (for mechanical fuel pump).
8. Install the supplied crankshaft pulley assembly. **Note: When installing the crank pulley, be sure the 1 .625" shim is placed between the triple V pulley & the crank pulley.**



**FIGURE B1**  
**OIL DRAIN FITTING LOCATION**  
**(BULLDOG)**



**FIGURE B2**  
**OIL DRAIN FITTING LOCATION**  
**AND ORIENTATION**  
**(HP 500)**



**POSSIBLE**  
**LOCATIONS TO**  
**"T" IN FUEL**  
**PUMP SAFETY**  
**SWITCH**

**OIL FEED LINE**  
**(PORT SIDE)**

**FIGURE C1**  
**OIL FEED LOCATION**



## **B. OIL DRAIN SETUP**

*Completion of this section will provide a connection for the oil return line, which returns oil from the ProCharger to the engine oil pan*

### **DESCRIPTION AND OPERATION**

The main components consist of the oil drain fitting and oil return line. The oil return line is routed from the ProCharger to the oil pan. The drain fitting is installed in the oil pan in an existing threaded hole or a hole punched by the installer. This is a gravity feed system, therefore, this oil return line must be free of kinks and downhill it's entire length, feeding into the pan above the oil level line.

### **Engines with cast aluminum pans (Bulldogs & Pre 1996 HP)**

1. Remove the 3/8" NPT plug located in the starboard side top (Bulldog) or on the ports side (HP500) of the engine oil pan. (refer to fig. B1)
2. Using silicone sealer or other hydraulic sealant, install supplied 3/8" NPT x 1/2" straight barb fitting.

### **Engines with stamped steel oil pans (1996 and later HP engines)**

1. On engines with non-offshore type mounts, punch (don't drill) a small (1/8") pilot hole 1" behind the fourth oil pan bolt hole from the engine's front on the port side of the pan, located 3" down from the pan's mounting flange. Stepping up punch sizes, enlarge the punched hole to approximately 9/16". For offshore engine mounts - punch and tap the drain hole 1/2" in front of second oil pan bolt and 2-1/2" down from the flange. (refer to figure B2)
2. Pack the flutes of a 3/8" NPT (National Pipe Thread) tap with thick grease. (FYI: 3/8" NPT refers to the pipe's inner diameter.) Tap hole in oil pan.
3. Coating the fitting's threads with hydraulic sealant, thread the supplied oil return fitting into the pan. Flush any foreign matter from inside of pan by connecting the drain line to the pan fitting and pouring roughly 1/2 quart of clean oil through.
4. Secure the return line using the provided clamp and perform an oil and filter change at this point.

## **C. OIL FEED SETUP**

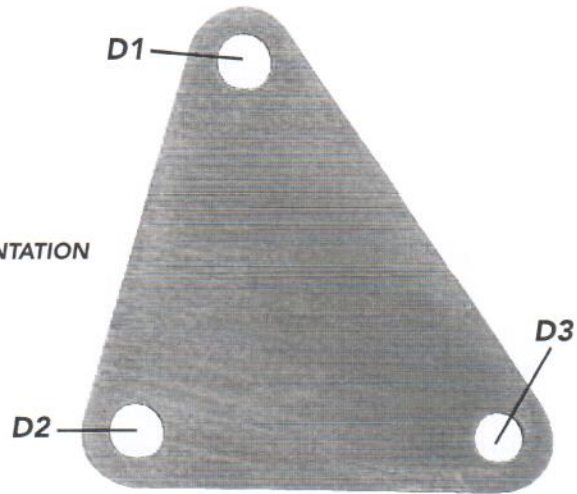
*Completion of this section will provide an oil feed from the engine to the ProCharger for lubrication of bearings and gears.*

### **DESCRIPTION AND OPERATION**

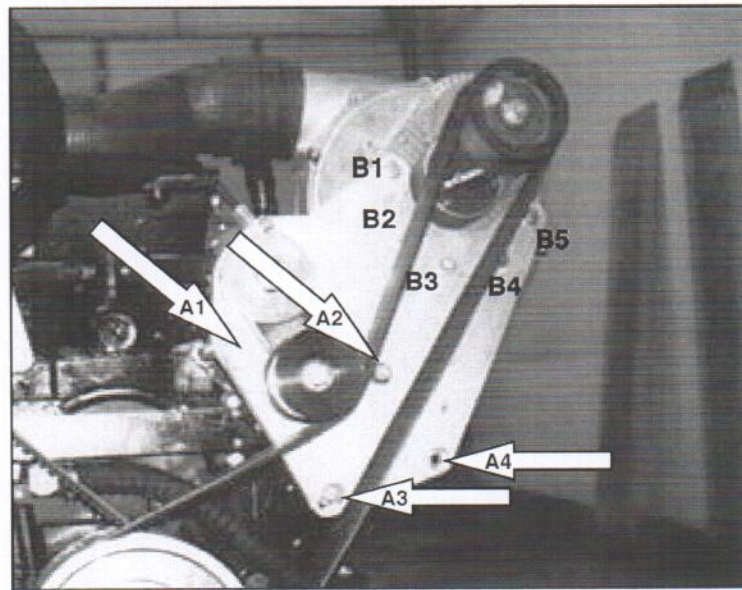
The main components consist of the oil feed fitting and oil feed line. The oil feed line is connected to a vacant port on the engine's oil galley providing an oil supply for the supercharger feed line. The oil at this location is just downstream of the oil filter. This supply is used to provide filtered, pressurized oil for the ProCharger's gears and bearings.

1. Locate & remove the 1/4" MPT plug located at the front of the oil galley running along the port side of the motor (directly above the pan rail, near the front corner of the engine, refer to figure C1).
2. With the plug removed, install the 1/4" NPT x -4 fitting in it's place.
3. Connect the oil feed line to the fitting. **Warning: Do not use Teflon™ tape or sealant on the fitting, as this could restrict or the ProCharger's oil supply passages and damage the precision bearings inside the ProCharger, voiding your warranty.**

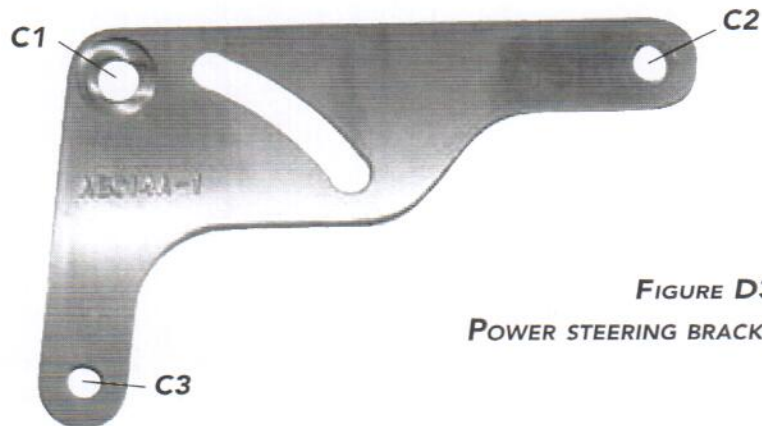




**FIGURE D1**  
**ALTERNATOR BRACKET ORIENTATION**



**FIGURE D2**  
**MAIN BRACKET ORIENTATION**



**FIGURE D3**  
**POWER STEERING BRACKET ORIENTATION**



## D. ENGINE ACCESSORIES AND PROCHARGER INSTALLATION

*In this section you will install the ProCharger and connect all related oil lines and air hoses*

### DESCRIPTION AND OPERATION

The main components of the ProCharger system are the ProCharger, the ProCharger mounting bracket, alternator bracket, and power steering bracket. The ProCharger is a gear-driven centrifugal compressor, driven by a 12 rib serpentine belt. It utilizes a billet aluminum impeller, super precision bearings and carburized gears. The impeller speed is dictated by engine rpm, crank pulley-to-driven pulley ratio and the ProCharger's final internal gear ratio. As engine speed is increased both airflow and boost (a function of engine back-pressure) are increased. The quoted boost levels of the kit may be exceeded if the factory-set redline is surpassed. The mounting brackets are flat billet aluminum types which utilize a series of spacers to properly position the ProCharger and alternator, and relocate the power steering pump.

1. Bolt the supplied triangular alternator bracket to the port side cylinder head aligning the lowermost hole on the head's face with hole D2 (refer to figures D1, B2) with the 7/16" x 1.5" long bolt. The bracket should be oriented in such a manner that hole D1 aligns with the upper head bolt hole and the 3/8" hole (D3) sits in the lower of the two positions (as indicated in figure D5, also refer to figure A1 for additional detail).
2. Attach the ProCharger main bracket to the engine using A1, A2, and A3. (refer to figure D2) Holes A1 & A3 use 4 1/4" spacers and 3/8" x 7.0" long bolts. Hole A2 uses the 3 3/4" spacer with a 3/8" x 7.0" bolt which feeds through the bracket, the spacer, and hole D1 on the alternator bracket (refer to figure D4).
3. Reinstall the original lower alternator support bracket in its original position. Slide the alternator up to align the upper support hole with hole D3 on the ATI alternator bracket and hole A4 (from behind) on the main bracket. Place the 3.25" spacer between the alternator and the main bracket. Feed the remaining 3/8" x 7.0" bolt through the main bracket, spacer, alternator, and alternator bracket and thread the 3/8" nylon locknut onto back side. Do not fully tighten the bolt until you tension the alternator drive belt.

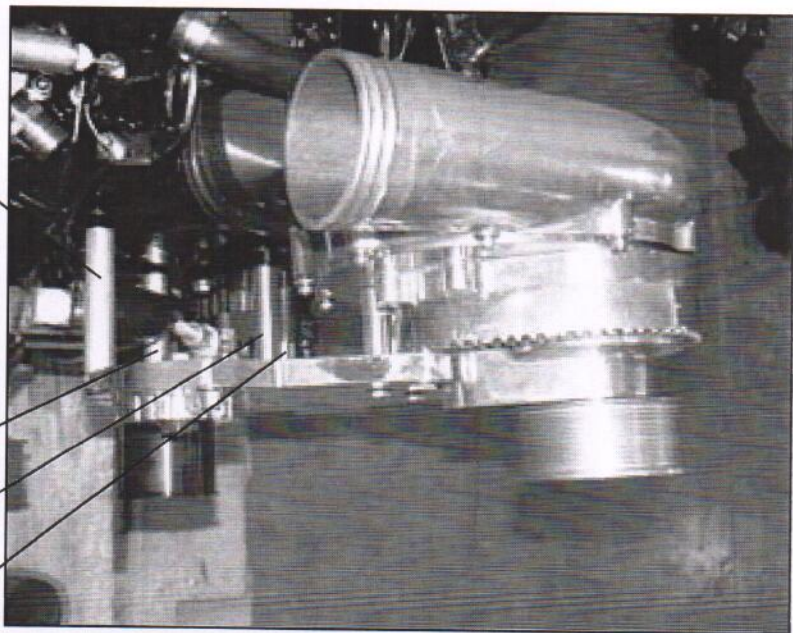
**FIGURE D4**  
**MAIN BRACKET INSTALLATION**  
**(VIEWED FROM ABOVE)**

5.75" SPACER

5.75" SPACER

5.25" SPACER

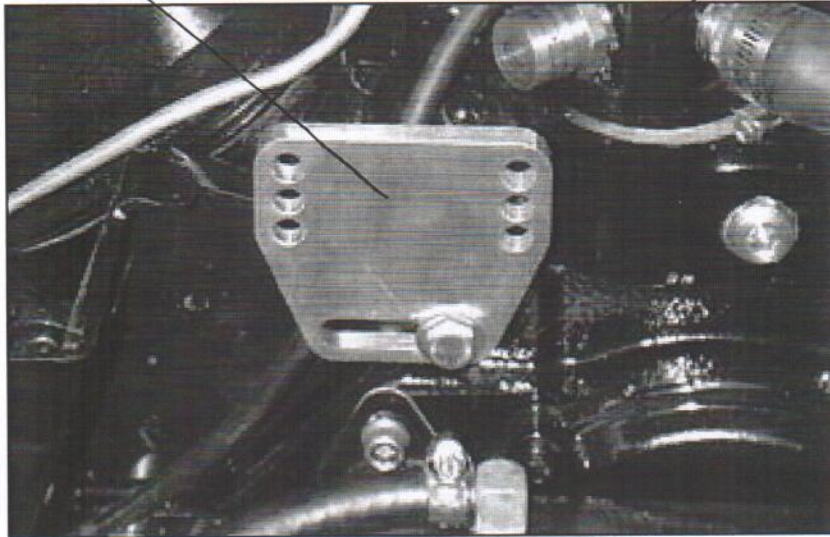
3.25" SPACER





**LOWER INTERCOOLER BRACKET**

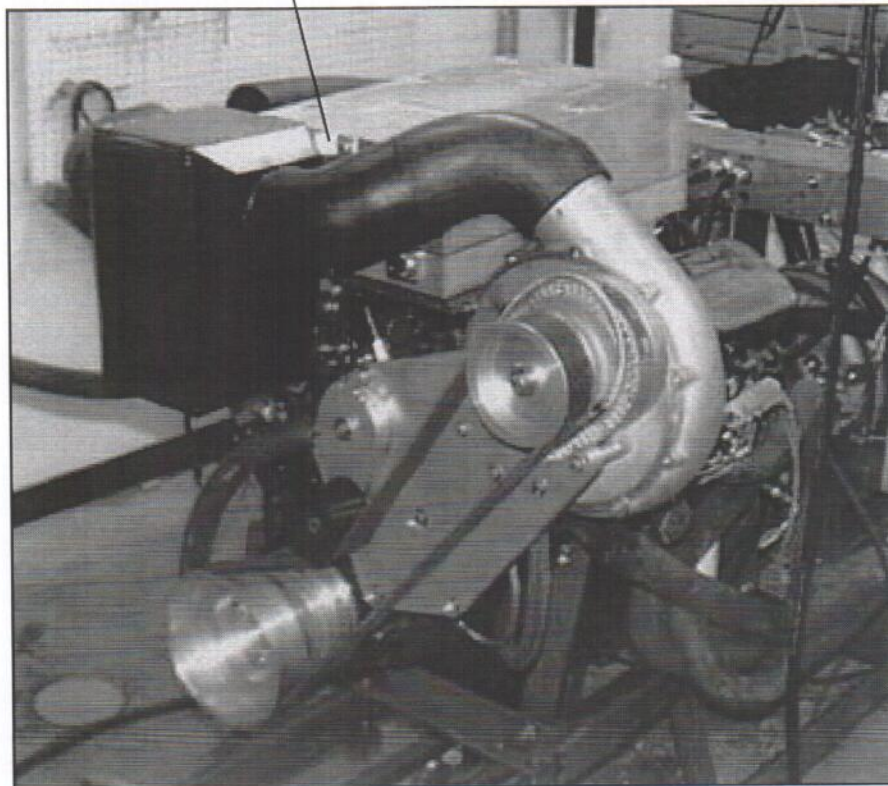
**THERMOSTAT HOUSING**



**FIGURE D5**

**LOWER INTERCOOLER BRACKET MOUNTED TO ENGINE**

**UPPER INTERCOOLER MOUNTING BRACKET**



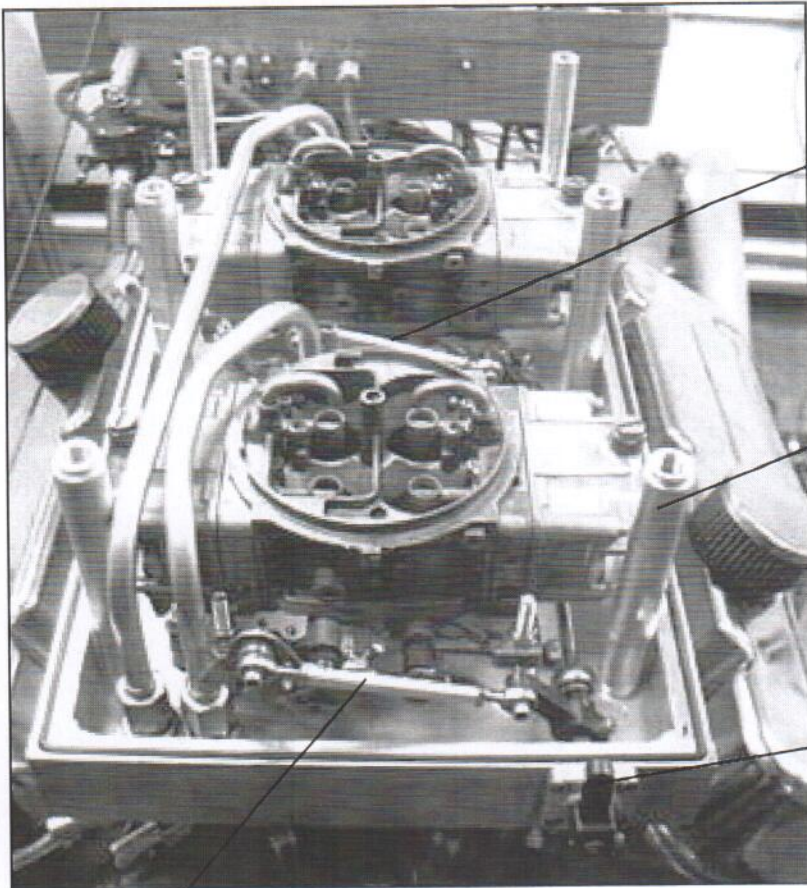
**FIGURE D6**

**PROCHARGER STAGE IV SYSTEM INSTALLED**



4. Attach the "pistol" shaped power steering bracket to the starboard side head oriented as shown in figure D3. The countersunk hole (C1) aligns with the outboard-most hole in the starboard head, with the 1.250" spacer placed between the power steering bracket and the head face. Hole C2 should line up with the inboard-most head bolt hole.
- 5a. If you will be mounting your intercooler remotely, follow 5b, otherwise proceed. The lower intercooler bracket should be installed as shown in figure D5 with the 1.25" spacer placed against the head, then the P/S bracket, with the 0.400" spacer to the front face of the power steering bracket, and behind the lower I/C bracket. Secure the bracket/spacer assembly to the head using the supplied 7/16" x 3.25" bolt. With the I/C (intercooler) mounting bosses facing the front of the engine, attach the I/C to the lower bracket using the provided 3/8-16 x 3/4" bolts & lockwashers (*Note: in some cases it may be simpler to attach the bracket to the intercooler first, and then install the entire assembly on the engine.*)
- 5b. Use the other 1.250" power steering spacer and secure the p/s bracket to the cylinder head with the provided 7/16" x 2-1/2" bolt.
6. Torque all bolts installed up to this point.
7. Remove the factory angled support bracket from the front of the power steering pump. Reverse the ends of the bracket so that the shorter end is nearest the pump and reattach.\*
8. Two bolts secure the seawater pump idler pulley to the seawater pump bracket, (HP only). Remove the upper of these two bolts.
9. Place two supplied shims over the lower power steering stud & install the power steering pump with the lower stud feeding through hole C3 in the power steering bracket. The upper stud fits into the arched groove. The lower support bracket bolts to the seawater pump bracket at the point where the bolt was removed in the previous step (hp only). For bulldogs, use the provided 0.600" spacer and 7/16 x 1-1/2" bolt to reconnect the lower power steering bracket. Thread the original nuts onto the pump mounting studs.
10. The power steering lines will need to be rerouted to reach the pump. The high pressure fitting should be brought up from underneath the pump (instead of from above as before) and threaded tightly. The return line should be replaced by the supplied section of 3/8" line, cut to proper length, and clamped onto it's fitting. The power steering pump pulley may need to be pressed farther onto the shaft as much as 1/8" to align with the crank pulley. Install the Gates #7390 belt on the alternator, the stock belt on the seawater pump, and the Gates #7417 belt on the power steering pump.





THROTTLE LINKAGE

STAND OFF  
(1 OF 6)

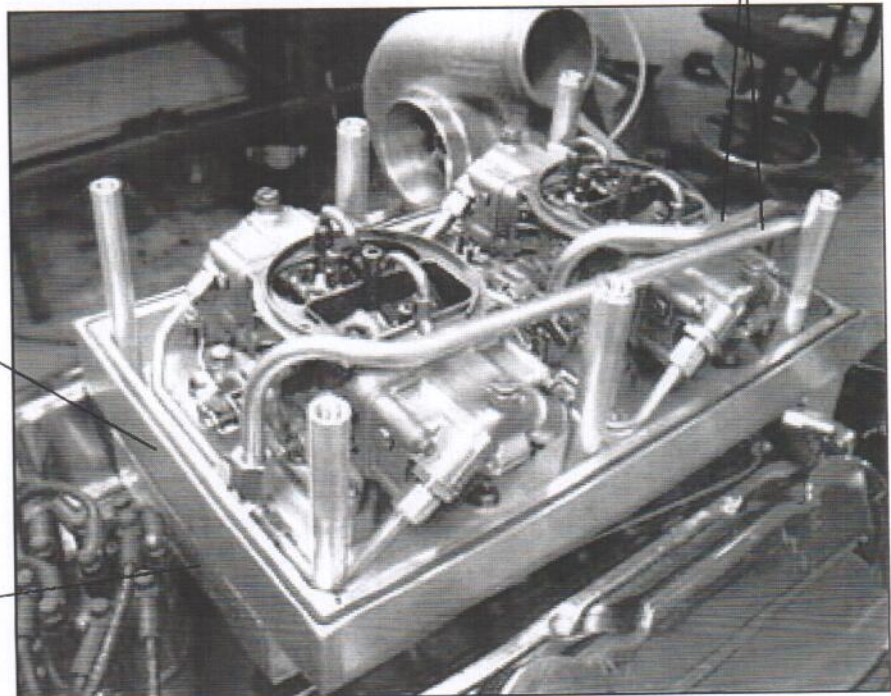
THROTTLE LINKAGE  
INTERFACE

**FIGURE E1**

**CARBURETOR ENCLOSURE ASSEMBLY**

THROTTLE LINKAGE

FUEL LINES



CARBURETOR MOUNTING  
PAD

ADAPTER BASE

**FIGURE E2**

**CARBURETOR ENCLOSURE ASSEMBLY**



11. Attach the upper intercooler bracket to the mounting holes on the top of the intercooler using two 3/8"-16 x .75" bolts and washers.
12. Mount the intercooler to the lower bracket using the 3/8"-16 1" bolts.
13. Using the supplied 5/16"-18 x 2.75" and 5/16"-18 x 1.25" bolts, the 1.37" spacers, and holes B1, B2, B3, B4, and B5 on the main bracket, attach the ProCharger to the main bracket, oriented as shown in Figures D2 and D6. Connect oil feed line to side of the ProCharger and tighten. Route the return line to the ProCharger oil return fitting on the bottom of the ProCharger, **making sure that the line runs continuously downhill from the procharger without any kinks or tight bends.** Trim the return line to the proper length, connect & clamp it to the supercharger's return fitting and clamp. Using the supplied adel clamps, secure the return line using the two lower crossover tube mounting bolts. Care should be taken to ensure that the line is kept clear of moving parts (ie: belts, etc.).
14. Place the serpentine belt around the crankshaft pulley and ProCharger driven pulley. The spring loaded idler should be pressing the belt downward from above. Tighten the long brass nut to tension the belt. Tension to the second of the three marks on the side of the tensioner. Tighten the 3/8" brass lock nut against the large brass nut, the 1/2" through bolt clamping the tensioner to the main bracket, the 3/8" bolt connecting the swing bolt to the back of the tensioner.

## **E. CARBURETOR ENCLOSURE INSTALLATION AND BOOST-REFERENCED FUEL DELIVERY**

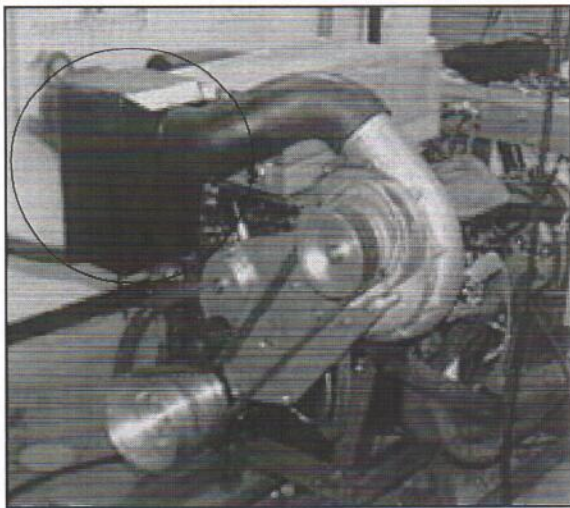
*In this section you will install the supplied carburetor enclosure, installing the carburetor inside of the enclosure, and connecting fuel lines and throttle linkage. **The fuel supply to the carburetor must be boost-referenced as instructed for adequate fuel delivery.***

### **DESCRIPTION AND OPERATION**

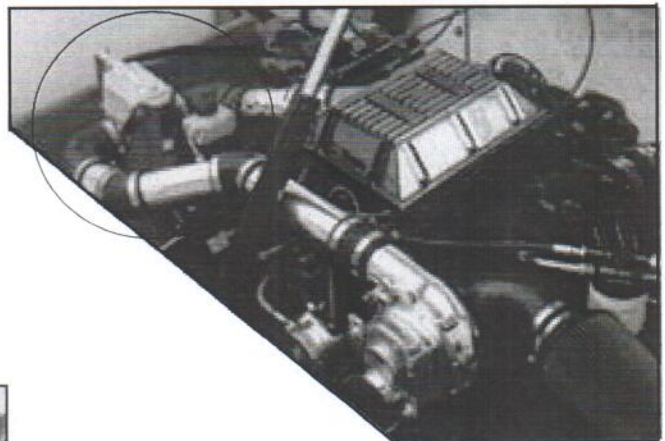
The carburetor enclosure is a 3-component enclosure (adapter base, carb mounting pad, lid) equipped with integral fuel line connections and throttle linkage to interface with Holley double pumper carburetors. The adapter base of this enclosure is designed to adapt the mounting pad to an Offenhauser p/n 5696 intake manifold. If the use of a tunnel ram is desired, an Edelbrock p/n 7075 "Victor Ram" will directly accommodate the carb mounting pad. The fuel supply feeding the carburetor must be boost-referenced in order to maintain sufficient fuel pressure. This means that a boost line is connected to your fuel system's regulator to increase your system fuel pressure by 1 psi for every 1 psi of boost pressure. For example, if your fuel pressure is 7 psi at idle and you run 9 psi of boost pressure without boost referencing, you would have -2 psi of net pressure (7 psi - 9 psi) forcing fuel back into your fuel tank! By utilizing a boost reference line, when your boost pressure reaches 9 psi your fuel pressure will now read 16 psi at the gauge. In this example, net pressure will still be 7 psi (16 psi - 9 psi), so you have maintained the same net fuel pressure you had at idle. Please refer to section E of the enclosed installation instructions for more information. **Failure to properly boost-reference your fuel system can result in severe engine damage!** You should also ensure that you have your carburetor jetted properly. **Never run a ProCharged motor with stock jetting!** Please refer to the tuning section at the end of this manual regarding jetting



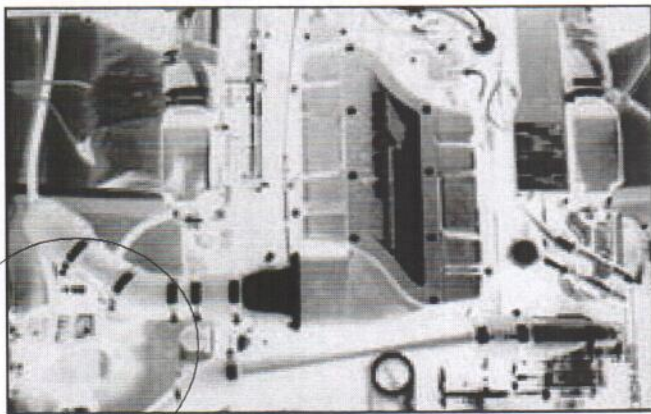




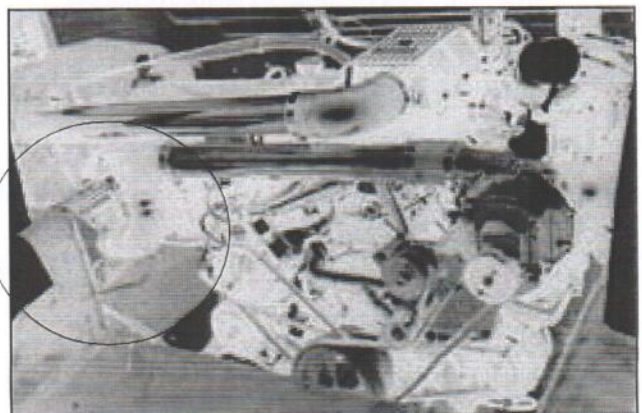
**FIGURE F1**  
*TYPICAL ENGINE MOUNT INTERCOOLER*



**FIGURE F2**  
*TYPICAL REMOTE MOUNT INTERCOOLER*



**FIGURE F3**  
*TYPICAL REMOTE MOUNT INTERCOOLER*



**FIGURE F4**  
*TYPICAL REMOTE MOUNT INTERCOOLER*



**Note: If not already completed, the carburetor should be modified & re-jetted as outlined in section H1**

1. Attach the base to the manifold using the provided 5/16" allen head bolts. With the base securely fastened to the manifold, the carburetor mounting pad may be installed using the provided 5/16" bolts & washers, and placing the provided gasket between the two parts. (*Note: use of a silicone sealant will enhance the gasket's sealing characteristics.*)
2. With the mounting pad installed, the carburetors may be installed in the enclosure, and the lines and linkages connected (refer to figures E1&E2).
3. It will be necessary to drill & tap holes to locate the throttle cable mounting stud, and a boost reference port for the the fuel pressure regulator, (this is due to differences in boats and installer preferences).
4. The enclosure lid may be installed using the provided 1/2" countersunk screws. *Note: some shifting of the stand offs may be necessary to align them with the holes in the lid.* With the lid in place, the upper intercooler bracket may be secured using the provided 5/16" x 1" bolts & washers.
5. Connect the 1/4" aluminum tubing (for boost-reference) between the fitting on the fuel regulator and the fitting on the carb enclosure using the supplied hose sections and clamps.



**Failure to securely connect this boost-reference line can result in severe engine damage!**

## **F. INTERCOOLER TUBING INSTALLATION**

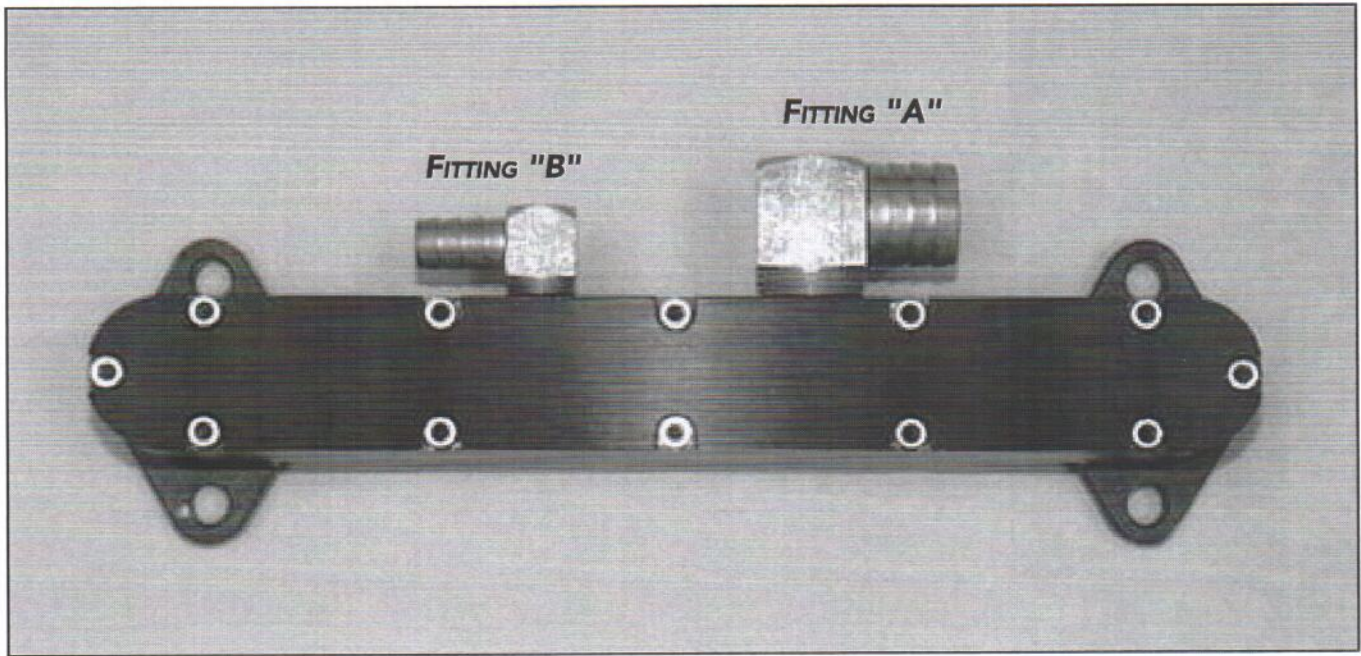
*The intercooler will either be mounted on the engine using the provided hardware, or remotely. If you are using an engine mounted intercooler, it should already be installed. If you are mounting the intercooler remotely, you will need to refer to the following procedures.*

### **DESCRIPTION AND OPERATION**

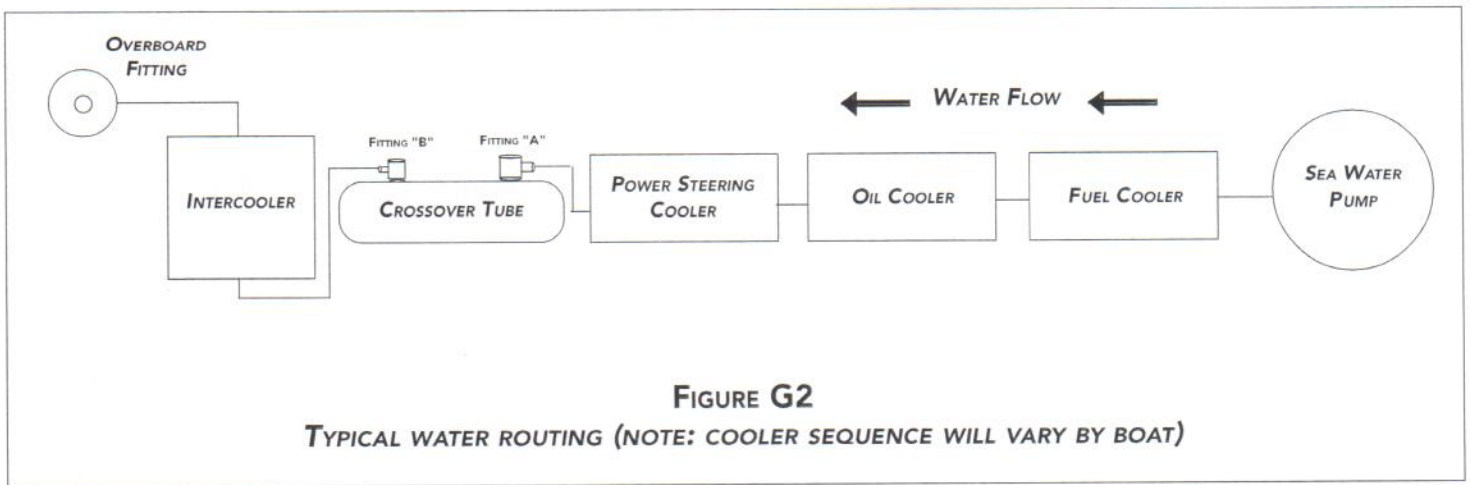
The intercooler system main components consist of the intercooler and tubing. The intercooler is a bar & plate style, air-to-water heat exchanger. The charge air (compressed and therefore heated) coming from the ProCharger enters the intercooler plenum, passing through a series of passages and exiting the opposite plenum. Fresh, cool water from the seawater pump flows through the crossflow passages in the intercooler, thereby cooling the charge air. The cooled charge air is then routed to the carburetors using a combination of steel and rubber tubing.

### **Engine mounted intercoolers:**

1. Connect the blower outlet to the intercooler inlet using the provided 4" 90° & 45° elbows. Approximately 1 to 1.5" will need to be removed from one end of each elbow to allow them to fit between the blower and I/C. The untrimmed ends of the elbows will need to be joined using the provided 4" slip connector. The 45° elbow will go to the intercooler, and the 90° will connect to the supercharger outlet.
2. The intercooler outlet will be connected to the enclosure inlet using a pair of 4" 90° elbows and a 4" diameter x 9" long connector tube. The elbow connecting to the intercooler outlet will need to be trimmed approximately 1" to properly align with the elbow connected to the enclosure.
3. Once all tubes & elbows have been fitted, they should be secured using the provided #64 clamps.



**FIGURE G1**  
**CROSSOVER TUBE WITH FITTINGS**



**FIGURE G2**  
**TYPICAL WATER ROUTING (NOTE: COOLER SEQUENCE WILL VARY BY BOAT)**



### **Remote mounted intercoolers:**

1. Review figures F2 - F4 before proceeding. Determine the location where you would like to mount the intercooler. The intercooler has several mounting tabs, find a place where these may be utilized, it should be out of the way of the engine, sitting close to the level of the ProCharger outlet. Ideally, it should be kept somewhat near the engine to minimize the distance the charge air has to travel, minimizing the number of bends it has to make (Refer to figure F2) for an example. After you have determined the ideal mounting location, fasten the tabs to the mounting surface. A straight section of strap has been provided for fabricating mounting brackets. At the bottom of the intercooler is another tab. Bend and drill the strap so that it may be bolted to the bottom tab and to another mounting surface.
2. A long section of 4" tubing has been included in your kit, this tubing will be used for intercooler ducting. After making a cut, clean the ends with a file or sander and flare the ends by closing the jaws of a crescent wrench allowing it to slip over the tubing wall. Pull outward on the wrench until approximately 1/4" of the wall is crimped outward at angle of 20°. Do this around the tube's entire perimeter. When flaring is completed, slip a rubber connector over the end to ensure that it is not overflared.
3. Measuring the distances, use a series of straight metal tubes, rubber connectors and rubber elbows, to connect the outlet of the ProCharger to inlet of the intercooler. (Note: the intercooler is non-directional, and the ports are interchangeable as inlets and outlets.)
4. Again, using a series of metal tubes, connectors, and elbows, plumb the intercooler tubing from the outlet of the intercooler to the 4" end of the elbow on the carburetor cover. Clamp all connections on the system securely with the provided hose clamps.
5. Examine your intercooler system to ensure that it is fastened rigidly (it will be full of water when in operation) and that it does not interfere with other systems within the compartment.

### **Air inlet system:**

1. Attach the bellmouth to the inlet of the ProCharger using the supplied hose clamp.
2. Using the supplied 1/2" x 4 ft. line, route the breather lines from the valve covers to the fittings in the bellmouth, trimming the line to the proper length, as required.

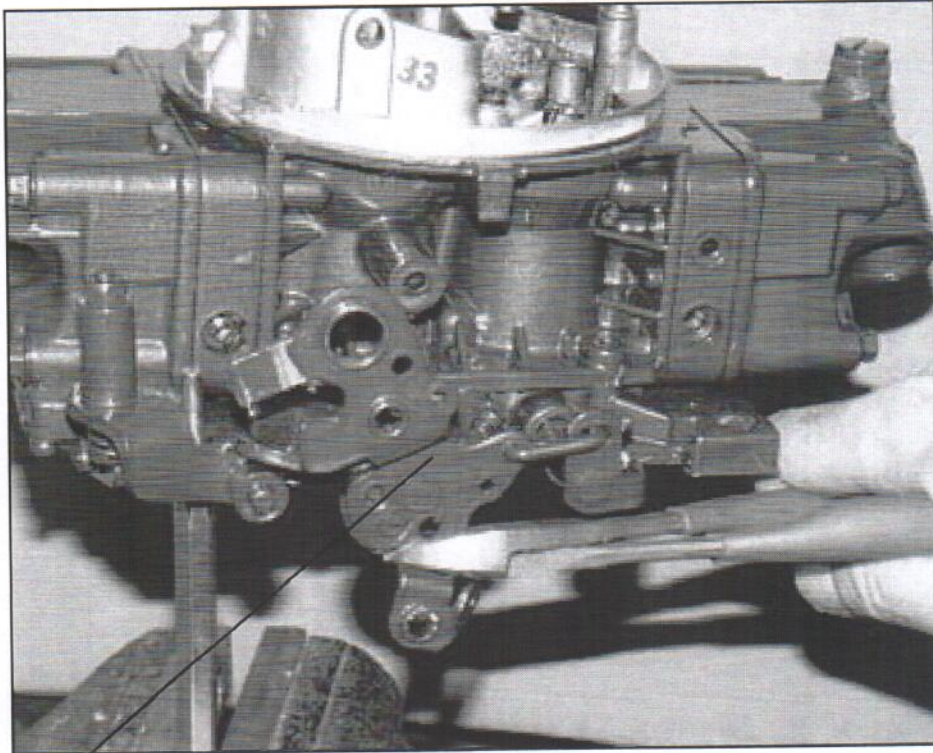
## **G. WATER LINE INSTALLATION**

### **DESCRIPTION AND OPERATION**

The water lines installed in this section allow water to be routed to and from the air-to-water intercooler. This is accomplished by routing hose to crossover tube fitting for the feed line, and installing an over board fitting for the discharge line.

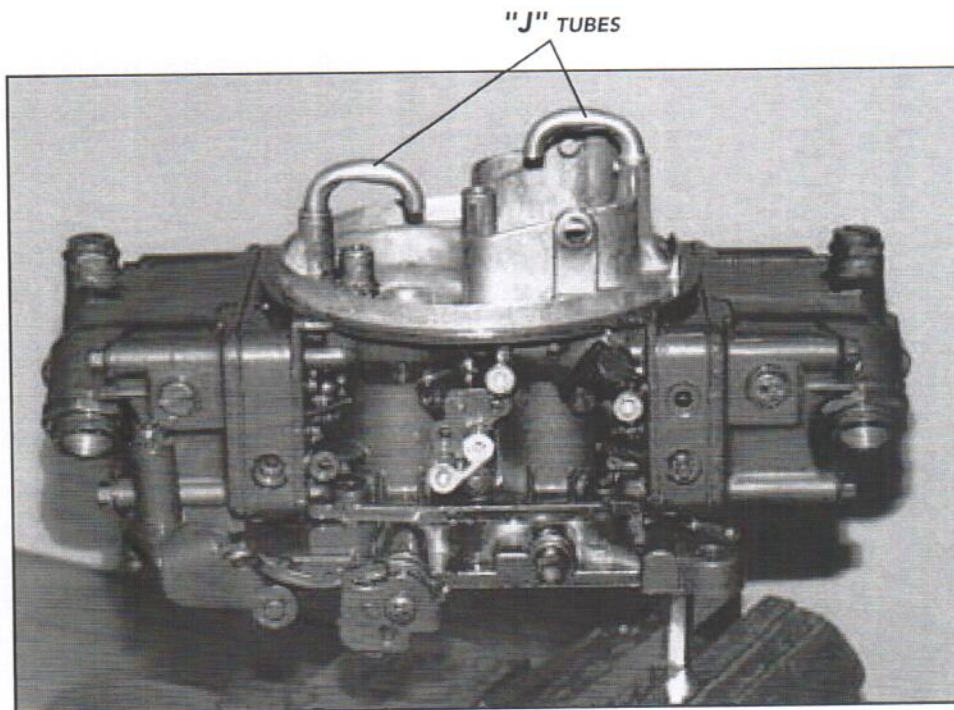
1. Attach the 1" water lines running from the exhaust to the fittings on the thermostat housing.
2. Attach the supplied 1/2" hose to small barb fitting on crossover tube. Routing the hose away from belts, attach to the lower intercooler fitting. **(It is important that the water feed line for the intercooler be attached at the bottom and the discharge at the top, otherwise the intercooler will not fill with water, providing little cooling effect.)**
3. Intercooler over board fittings may be located in either of two locations, above the drive unit for cooling (if not using drive shower) or on the driver's side of hull (for verification of water flow through the intercooler). Drill a hole to match the size of the outer diameter of the supplied overboard fitting. Coat the outside of the fitting with silicone and slide through the hole with the barb fitting to the inside. Tighten the fitting's clamp nut to secure it to the hull. Attach the remaining 1/2" hose to the top fitting on the intercooler, routing the free end of the hose to the over board fitting, clamping securely at both ends.





THROTTLE LINKAGE

FIGURE H1  
CARB LINKAGE MODIFICATION



"J" TUBES

FIGURE H2  
"J" TUBES INSTALLED



## H. FUEL SYSTEM UPGRADES (SEE APPLICATION GUIDE ON FACING PAGE)



**Warning:** Ensure that all fuel lines are correctly sized for the supercharged horsepower rating of the engine. Please contact an ATI service technician should you have any questions.

### H1. MARINE BLOW-THROUGH CARBURETOR MODIFICATION

1. Remove the two screws attaching the choke butterfly to the pivot shaft. With the butterfly removed, disconnect the shaft from the choke actuator rod and remove it from the choke tower. Remove the three choke linkage retaining screws from the starboard side of the carburetor & remove the linkage assembly from the carburetor.
2. Trim the portion of the throttle linkage protruding below the carburetor's baseplate. Cut or bend the tab protruding from the carburetor throttle linkage to prevent it from interfering with the side wall of the carb enclosure (refer to figureH1).
3. Remove the front and rear float bowls from the carburetor. Remove the stock floats and replace them with the supplied black nitrophyl floats. Notched floats (for use with jet extensions) should be installed on secondary float bowls. At this point, you should re-jet the carburetor and reinstall the float bowls.
4. If your carburetor is not marine equipped, remove the straight (automotive type) bowl vent tubes with pliers, and install the supplied "J" shaped vent tubes in their place (refer to figureH2). Tap the tubes into place with a hammer (they should fit tightly, but care should be taken to avoid denting of the tubes).

### H2. COMPETITION ELECTRIC FUEL SYSTEM INSTALLATION

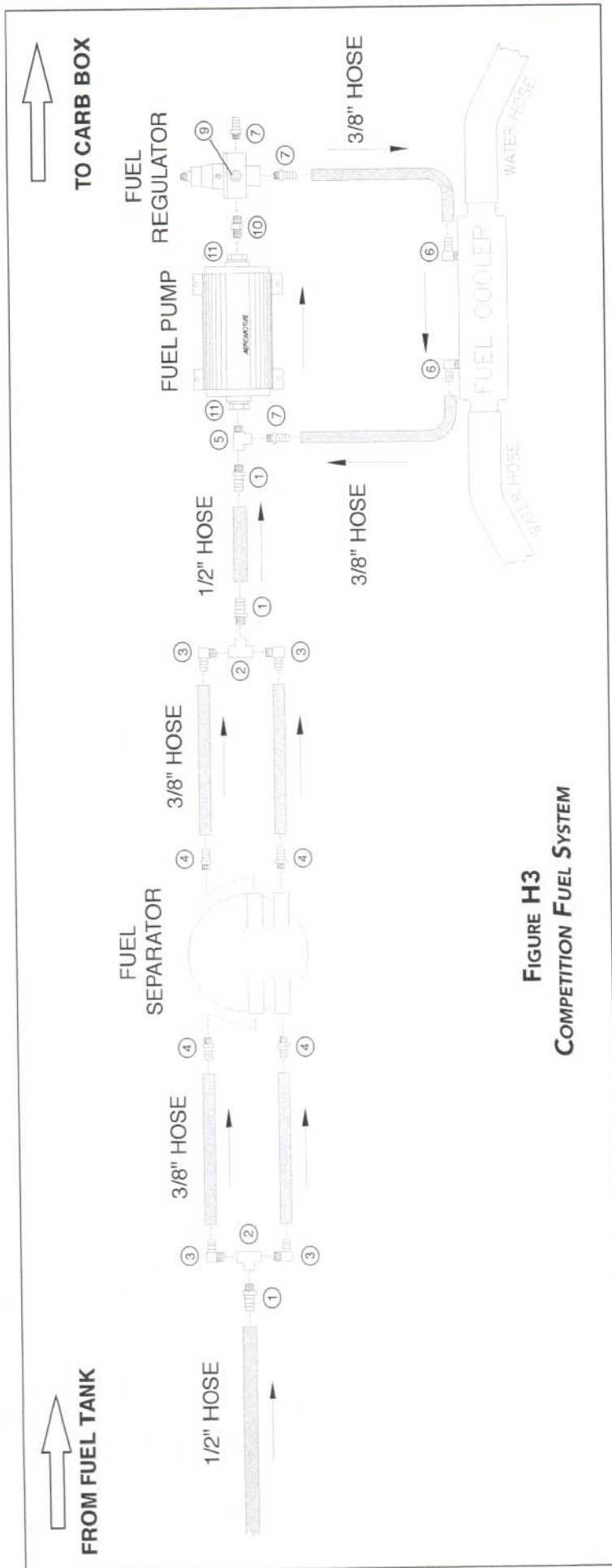
\*In this section, you will replace the stock fuel lines with higher flowing lines and install a larger capacity fuel pump.

**Note:** The system should be configured with one fuel pump for each carburetor to ensure adequate fuel delivery.



**Warning:** Fuel Fittings and hoses from the tank must be sized according to horsepower level. Also, stock anti-siphon valve (or equivalent) must be removed and replaced with a manual valve that meets fuel flow and coast guard requirements. Please contact an ATI service technician if you have any questions.

1. Visually inspect fuel lines from tank to separator to make sure that there are no kinks or restrictions. If the fuel line from the tank is less than 1/2" hose, it will need to be replaced with supplied 1/2" hose.
2. Select a location near the water separator where the electric fuel pump will be mounted (usually somewhere along the stringer). You will want to find an area as low as possible with a straight run spanning roughly 2 feet. Ideally, the fuel pump should be mounted below the tank outlet to allow a gravity feed. However, the pump can be mounted a maximum of 10 inches above the tank outlet if need be.



**FIGURE H3**  
**COMPETITION FUEL SYSTEM**

**FUEL SYSTEM FITTINGS:**

- ① 3/8" MPT X 1/2" BARB
- ② 3/8" FPT "T" FITTING
- ③ 3/8" MPT 90 DEGREE TO 3/8" BARB
- ④ 1/4" MPT X 3/8" BARB - STRAIGHT
- ⑤ 3/8" MPT X 3/8" FPT X 3/8" FPT TEE
- ⑥ 3/8" MPT X 3/8" BARB 90 DEGREE
- ⑦ 3/8" MPT X 3/8" BARB
- ⑧ 3/8" MPT X 3/8" BARB 90 DEGREE
- ⑨ 3/8" MPT X 1/8" FPT REDUCER
- ⑩ 3/8" MPT X 3/8" MPT UNION
- ⑪ 10 AN X 3/8" FPT REDUCER

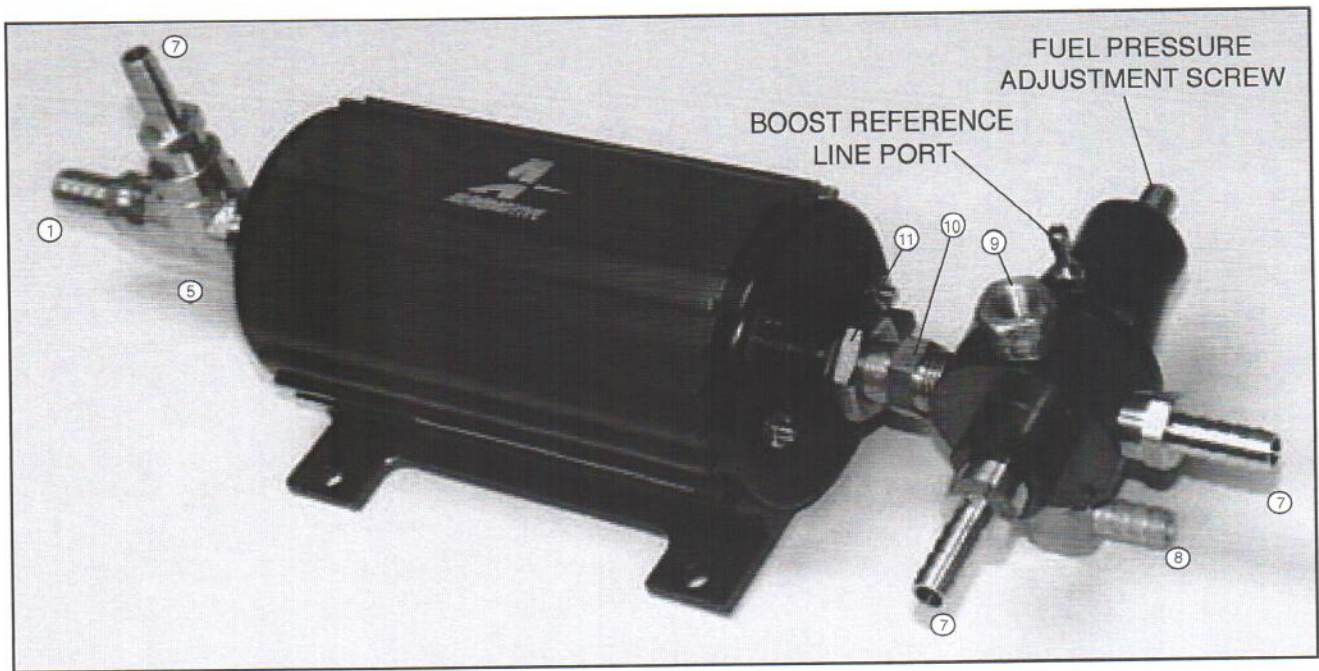




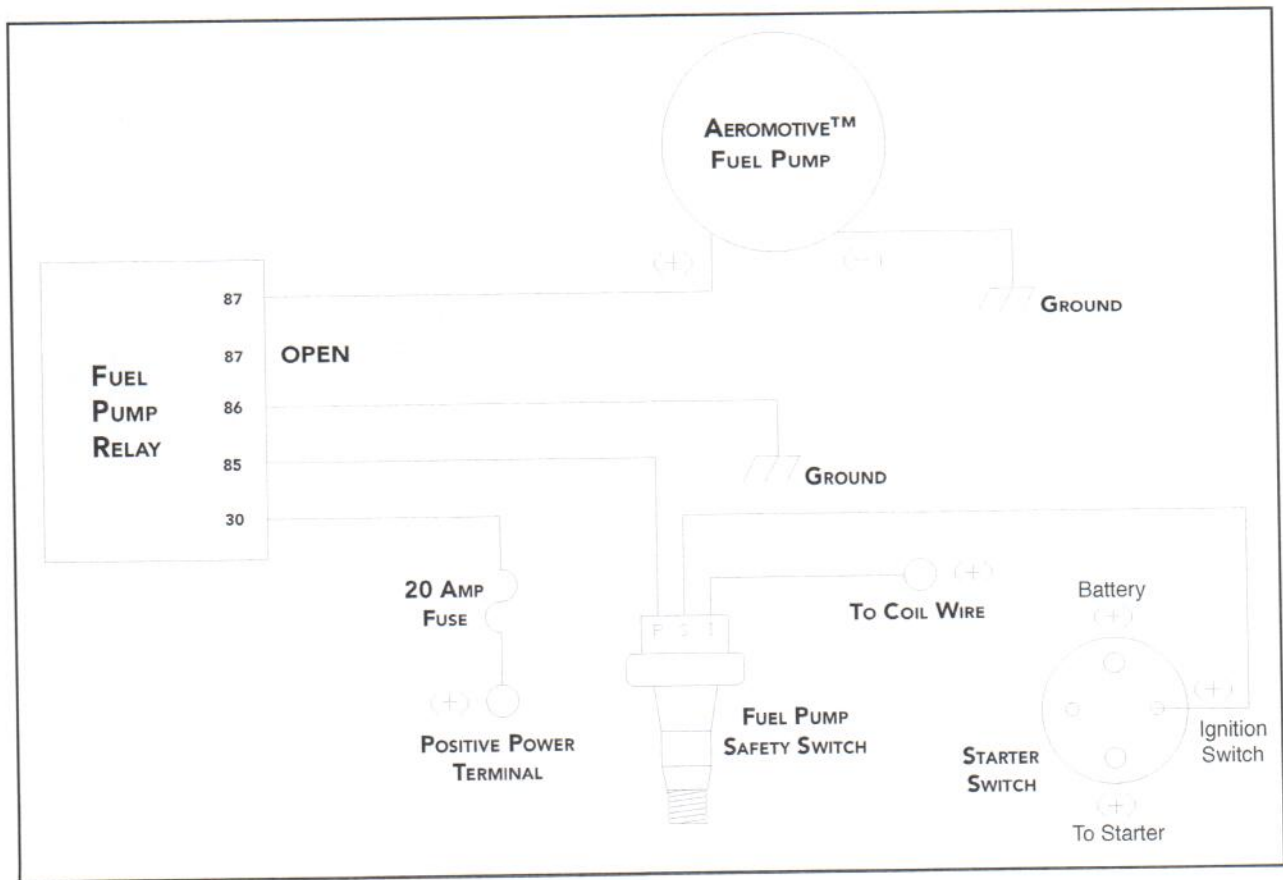
**Note:** Your competition fuel pump should be assembled as shown in Figure H4. The fuel pump and regulator are shipped connected together but they can be separated and mounted separately if there are space limitations. Make sure all fittings are tight. Refer to the fitting list on page 22. Use the supplied 1/2" and 3/8" hose to replace the stock fuel line from the fuel tank forward. Your new fuel system will look like Figure H3 when you are finished with this section.

3. Place the pump where you intend to mount it. Use the pump's mounting bracket as a template and mark holes on the mounting surface. Using a 1/8" bit, drill the marked holes. Using the provided #12 screws, attach the fuel pump bracket.
  4. Remove the existing outlet and inlet fittings from the water separator. Replace with 1/4" MPT x 3/8" barb fittings. Use fittings and corresponding fuel lines to set up the fuel system as shown in Figure H3. Securely hose clamp all lines with supplied hardware.
  5. The supplied fuel cooler can be mounted anywhere within the water path. Refer to figure G2 and H3. The cooler is 9" in length, so find a spot along the rubber hoses that is at least 8" in length and relatively straight in which you can splice in the cooler. Connect the fuel inlet of the fuel cooler to the bottom *straight* hose barb fitting coming out of the fuel pressure regulator with the supplied 3/8" rubber hose. Secure with hose clamps. Next, connect the fuel outlet of the fuel cooler to the the "T" fitting (# 5 fitting in figure H3) with the supplied 3/8" rubber hose. Secure with hose clamps.
  6. Fitting #9 in figure H4 is for a fuel pressure quage. ATI strongly recommends the used of a fuel pressure gauge to allow for tuning and to also monitor your engine. If you do not install a gauge in this fitting, **be sure to install a plug or fuel will spray out of the regulator when the fuel pump pressurizes.**
  7. Install the supplied fuel pump safety switch in a location where there is positive engine oil pressure. Figure C1 shows two possible locations where this switch can be "T" in.
  8. Find a place near the fuel pump to mount the fuel pump relay. You may mount it using the remaining #12 screw or an existing fastener.
- \*(Refer to Figure H5 for the following instructions)
9. Using an electrical "T" connect the yellow wire from the relay (#87) to the positive (+) lead on the fuel pump.
  10. Connect the black wire from the relay (#86) to the ground (-) lead on the pump.
  11. Run the red wire from the relay (#30) to the power terminal on the alternator or on the battery using the supplied 20 Amp. inline fuse and ring connector.
  12. Attach the green wire from the relay (#85) to the (P) terminal of the fuel pump safety switch.
  13. Connect a wire running from the (I) terminal of the fuel pump safety switch to a switched power source (one that is only powered with the key in the "on" position such as the coil).
  14. Connect a wire running from the (S) terminal of the fuel pump safety switch to the (+) ignition terminal on the starter switch (located on the starter).
  15. Run the black ground wire(s) from the fuel pump to a ground on the engine.
  16. Turn the key to the on position. The pump should run. If unsure, you can feel the pump vibrate as it activates. If the electric pump does not operate, double check all connections.



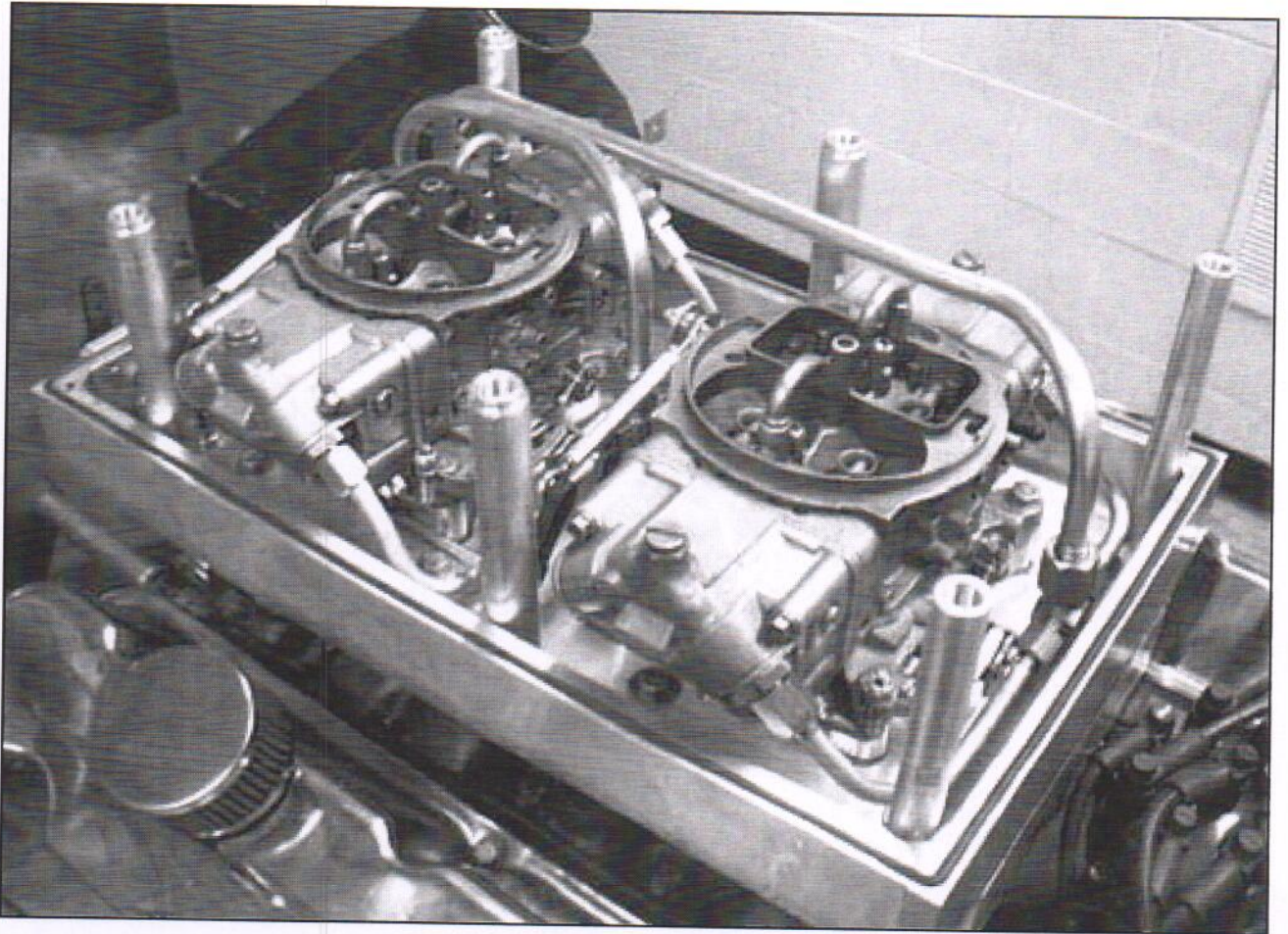


**FIGURE H4**  
**COMPETITION FUEL PUMP**  
**ASSEMBLY**



**FIGURE H5**  
**COMPETITION FUEL PUMP RELAY**  
**WIRING SCHEMATIC**





**FIGURE I1.**  
**INSTALLED ENCLOSURE (LESS LID)**

## I. INSTALLATION REVIEW AND SAFETY CHECK

1. Carefully review the entire installation (figure I1). Check oil and fuel lines near moving parts and the exhaust system to ensure that these lines are safe, secure and not twisted or kinked. All wires and hoses should be firmly secured with clamps or wire ties. Also, ensure that the air filter or inlet screen is installed.
2. Check all fluid levels. Your tank should be filled with 91 octane or higher fuel before any hard running.
3. Start engine and idle for a few minutes. You should be running stock Mercruiser timing. Check and adjust as necessary. It is better to start with less timing and no detonation!
4. Shut off engine and check for fluid leakage, signs of abrasion between contacting parts, and other potential problems
5. Your engine should exhibit a significant increase in performance when you are into the throttle, with no signs of detonation present. If this is not so, review your installation, then contact your dealer or ATI for assistance.
6. For best performance and reliability, **always use premium grade fuel (91 octane or higher)** and listen for signs of detonation. Back off of the throttle, if detonation should occur. With a properly installed ProCharger and appropriate timing, detonation will not be an issue. Contact your dealer if any signs of detonation are present, this is an indication of an installation problem, and it should be corrected immediately.
7. Never race your engine (and ProCharger) when your engine is cold. Allow the water temperature to climb into operating range for several minutes before revving above 2,500 rpm, to ensure adequate oil lubrication.
8. Be sure you have purchased and properly installed a fuel pressure gauge and/or fuel/air ratio meter to monitor fuel delivery. Installation of a boost pressure gauge is also recommended. **Important: Your fuel pressure must increase pound for pound with your boost (Example: if your idle fuel pressure is 8 psi and you make 5 psi of boost, your boosted fuel pressure should be 13 psi.). If your fuel pressure does not increase with relation to boost, do not operate engine into boosted range, as engine damage may occur.** Verify all fuel system plumbing, as well as the routing of the boost reference line feeding from the carb box to the fuel pump.
9. It is very important that all fuel lines are sized according to the supercharged horsepower rating of the engine. This includes the anti-siphon valve, fuel filters, etc. . Please contact an ATI service technician should you have any questions.
10. Please review the maintenance and warranty sections within this owner's manual





# TUNING

## Fuel Pressure and Jetting

On a carbureted engine, adequate fuel pressure and correct jetting are the most important factors in maintaining the correct fuel-air ratio. When supercharging a carbureted engine, fuel beyond that which is supplied by the stock fuel pump and carburetor/jets will be required, due to the increased mass of oxygen in the cylinders. This extra fuel is provided by upgrading your fuel systems and increasing the jetting on a Holley double pumper carburetor beyond stock levels (see fuel systems recommendation chart on back of price list and in section H of this manual). Variations in fuel pressure gauges can cause improper fuel pressure readings on the gauge; therefore, what is important is the observed **increase** in fuel pressure (not the overall fuel pressure, but the amount of additional pressure added to the stock pressure at idle). After the system is installed, fuel pressure at idle should be checked. Whatever that reading is, under boost you should see an increase of 1 psi of fuel pressure for every 1 psi of boost pressure. It is extremely important to check the fuel pressure as the engine may seem to run fine, **but as a result of insufficient fuel delivery, may be dangerously lean and exposed to serious engine damage.** Carburetor jetting must also be correct. Never run a ProCharged engine with stock jetting! ProCharged engines will always require jets larger than the factory equipment. Please contact your dealer or an ATI technician regarding jetting recommendations.

## Timing

All engines will require subtly different timing for best tuning. However, as most engines exhibit similarities, we can provide some general guidelines. Most medium sized V Hulls, twin engine applications, and generally boats with 1.50 gear ratios or lower (numerically higher) that are able to plane with relative ease in a tall propped, high speed setup, will generally not require as much initial timing. Dyno results have shown that most moderate compression GM BB's, such as Mercruiser types will generally exhibit insignificant variances in peak HP when total timing is kept between 29-32°. However, in the previously mentioned boat types which exhibit good planing & driveability characteristics, backing the timing down from the 32° Merc. Stock setting may provide an additional margin for error in the event of the boat being operated with insufficient octane fuel and/or other abuses. Large single engine boats, high speed tunnel cats, and other high performance and/or 1.36 geared boats may benefit from the more advanced Merc. total 32° specification, since this will essentially increase on-plane torque due to non-aggressive low RPM tuning. Although this aggressive timing will not allow as great a margin of error at WOT, this should not present a problem, due to the fact that these high performance applications are typically capable of only short bursts of full throttle operation due to water speed and general safety conditions. Also consider the fact that the total timing will influence the final jetting of the carburetor.

## Plugs

As to reading the plugs, the following information may help you identify what you are looking for. What we want to focus on is the end threads. These threads are directly connected to the cylinder, and by removing the spark plug you are literally removing a portion of the combustion chamber. Most generally, the end of the plug threads are an accurate indicator of the chamber and piston's appearance. The threads and chamber should be lightly, evenly blackened with soot. This is representative of a rich supercharged condition and indicates cooler exhaust gas temperatures. The negative ground should be clean, showing no signs of blue discoloration. The insulator should be clean and white; this indicates thorough combustion. The following are signs of problems: If the ground electrode is discolored, it indicates excessive cylinder temperatures. If the electrode is fuel soaked or black this indicates a misfire or fouled plug condition. If any of the first thread is not completely blackened, there is not enough fuel present in the cylinder. Even if only a small part of the thread's circumference is clean, this condition may produce excellent power, but produce excessive cylinder temperatures.



## **CHECKING YOUR EGT'S AND/OR READING YOUR PLUGS IS EXTREMELY IMPORTANT!**

Many activities that are good for you are usually not too enjoyable. Fortunately, when it comes to your marine engine, the simple process of monitoring your exhaust gas temperatures (EGT's) or reading your plugs can save thousands of dollars of unnecessary engine repairs and provide many enjoyable hours of trouble free service.

Monitoring EGT's requires the installation of EGT probes and gauges. If you are not familiar with this process, contact your dealer or an ATI service technician. Reading your plugs is a relatively simple alternative to monitoring EGT's, but is not as precise.

As for reading plugs, we must first start by saying that **when** a plug is read is as important as **what** is observed. If a spark plug is removed & read at the wrong time, not only will a misdiagnosis occur, but in many cases the tuner may actually mistakenly tune the engine incorrectly, unintentionally creating a lean condition. Therefore, the proper way to read plugs is to remove the spark plugs immediately following a wide open throttle, full power condition. This is done by accelerating at wide open throttle to full operating range for a few seconds, or until it is clear that rapid acceleration has ceased ( in most marine engines a good plug reading can be taken from 4500 to 5500 rpm) and then immediately shutting off engine and coasting to a stop. Although many spark plugs may only require less than a few minutes each to be read & completely reinstalled, this previously described process provides a terrific opportunity to literally take a snapshot of the combustion process and what is happening inside the engine.

If a hundred engine builders were asked to estimate what it would require to properly tune your engine there may be a hundred different answers since no two engines are exactly alike. It is called the cumulative tolerances theorem, a half a percent difference in total valve lift, a slight variance in piston ring gap, a small amount of unremoved casting flashing in a cooling passageway, and hundreds of other minute differences can lead to identical engines requiring some differences in fuel pressure to produce proper and uniform combustion. To properly read a spark plug we must first have the correct spark plug. Most Champion, AC & other GM spark plugs are easy to read; however, many Ford Motorcraft are black in color & therefore difficult to read. It is suggested for best results that a brand new set of spark plugs be installed before any attempts to gather information. Let us remind you the following tuning tips are based on unleaded pump gas operations in the stock compression ratio range. Since today's pump fuels register significantly lower octane ratings, and therefore are significantly more susceptible to engine knock or ping, than yesterdays high octane fuels, it is important that some additional fuel be placed in the cylinder - not to be burned, but to act as a cooling medium. This means a richer than "ideal" air fuel ratio is now highly desired for maximum performance. Never operate a ProCharged engine with factory jetting! ProCharged engines will always require larger than stock jets. Please contact an ATI technician if you have any questions regarding jetting recommendations. You will still need to read your plugs to finalize the jetting, but ATI Technical Service can at least give you a good starting point. Remember that leaning out the engine may increase HP but will create an extremely dangerous lean condition - which can result in severe engine damage.

**If you require technical support, please contact us at (913) 338-3086 9:00-5:00 CST  
Monday - Friday or, contact technical services via email at [techserv@procharger.com](mailto:techserv@procharger.com)**



# OPERATION AND MAINTENANCE

- **COLD STARTING**

Never race your engine (and ProCharger) when your engine is cold. Allow the water temperature to climb into operating range for several minutes before driving above 2,500 rpm, to ensure adequate oil lubrication.

- **FUEL QUALITY**

For best performance and reliability, **always use at least 91 octane fuel**. Always listen for signs of detonation after refueling, and after replacement or modification of any fuel system components. Back off throttle should detonation occur. With a properly installed ProCharger intercooled supercharger system, detonation should not be an issue

- **OIL AND FILTER MAINTENANCE**

Always change your oil and filter every 25-30 hours. Delaying your oil change beyond the recommended interval risks the health of both your high performance engine and ProCharger.

- **IGNITION SYSTEM MAINTENANCE**

If your spark plugs are more than two years old or have more than 100 hours use, you should change your plugs before operating your boat under load. Additionally, spark plug wires should be changed every 200 hours of use, or whenever resistance exceeds factory specifications.

- **AIR FILTER MAINTENANCE**

Your air filter should be cleaned every fifty hours of use or annually. A clogged air filter will result in degraded boost and performance. K&N air filter cleaner is recommended, and be sure to re-oil the cleaned filter before re-installing. **Your motor and ProCharger should never be run without an air filter or inlet screen!**

- **BELT TENSIONING AND REPLACEMENT**

The belt which turns your ProCharger will stretch after initial run-in, and may need retightening after the first few hours, if not sooner. After possibly one more tightening of the belt with the tensioner, further stretching should not occur. Tighten the belt sufficiently to avoid slippage, but do not overtighten, as this could cause damage to the ProCharger's precision bearings. Should you throw a belt and find that it needs constant retightening, the belt is damaged and should be replaced. 8-rib belts can be bought from ATI or your local parts store. Gates Micro-V belts are recommended; these belts are available at CarQuest™, NAPA™ and other auto parts stores. Your nearest CarQuest store can be found by dialing 800-492-7278, the nearest NAPA store at 800-538-6272.

- **IMPELLER SPEED**

Maximum impeller speed should not exceed the redline stated for each model in the table below. Maximum impeller speed = crankshaft pulley diameter (N1) divided by supercharger pulley diameter (N2), multiplied by the step-up ratio stated in the table, multiplied by engine rpm at redline.

$$\text{Impeller RPM} = (N1/N2) \times (3.05 \text{ or } 4.44) \times \text{engine RPM}$$

Model:	M1B	M1	M1SC	M2	M3SC	M3	M4
RPM (MAX):	54,000	50,000	57,000	59,000	50,000	53,000	50,000
Step-Up Ratio:	3.05:1	3.05:1	4.10:1	4.44:1	4.10:1	4.44:1	4.44:1



## **THE PROCHARGER® AND PROCHARGER INSTALLATION SYSTEM LIMITED WARRANTY**

Accessible Technologies, Inc. ("ATI") is proud to offer a twelve-month limited warranty on its ProCharger products. ATI's warranty obligations are limited to the terms set below:

ATI warrants the ProCharger and ProCharger installation system (together "product") against defects in materials and workmanship for a period of TWELVE (12) months from the date of original purchase from your local dealer, or date of shipment from the factory if purchased directly from ATI. If the product is used in its intended manner, ATI will repair or replace any component found to be defective at no charge to the customer. **SHOULD THE CONSUMER ELECT TO USE A DRIVEN PULLEY OTHER THAN THE ORIGINAL PULLEY SHIPPED WITH THE SYSTEM, THIS TWELVE-MONTH LIMITED WARRANTY IS VOID.** This warranty coverage is extended only to the original consumer purchaser, and excludes hoses, sleeves and electronic support components manufactured by other companies.

To obtain service under this warranty you must do the following during the warranty period:

1. Phone ATI (913-338-3086) and provide us with the following information:
  - ProCharger serial number
  - vehicle year, make, model, engine modifications and other modifications
  - description of perceived problem
2. If no solution to your problem can be found after the above phone conversation, you will be assigned a warranty claim number. You must then properly ship your product, at your expense, to the ATI factory. The product should be carefully packaged in a rugged box so that none of the components being shipped could strike each other or the side of the box during shipping. The box should be strong enough to safely contain the weight of the components being shipped.
3. Include the following information inside the box with your product:
  - copy of your original invoice or receipt
  - name, address and daytime telephone number
  - warranty claim number
  - vehicle year, make, model, engine modifications and other modifications
  - description of perceived problem
4. Clearly mark the warranty claim number on the top and one side of the box in characters no less than 2" tall. Ship the properly packaged product, prepaid and insured for the retail value of the component(s) being returned, to the following address:  
Accessible Technologies, 14801 West 114th Terrace, Lenexa, Kansas 66215.

ATI agrees to honor a warranty claim at its sole discretion and only after inspection by engineers at the ATI factory. No warranty will be honored if any product subassembly is found to have been improperly installed, tampered with, mis-handled or misused in any way. **DISASSEMBLY OF THE PROCHARGER OR REMOVAL OF THE PROCHARGER SERIAL PLATE VOIDS ALL WARRANTIES.** Claims for freight damages should be directed to the freight company.

If ATI's limited warranty applies, your product will be repaired or replaced at ATI's option and shipped back to you, freight prepaid, via UPS ground service. If the limited warranty does not apply, we will advise you of the specific reason for denial, and advise you of repair expense and timing. After advising you of this information we will, at your option, either proceed with repairs or return your product to you in the state in which it was received. In either case the product will be shipped to you COD, insured at replacement value. This means that you would pay the return shipping and insurance charges if ATI's limited warranty does not apply to your product.

THE WARRANTY AND REMEDIES SET FORTH ABOVE ARE EXCLUSIVE AND IN LIEU OF ALL OTHERS, WHETHER ORAL OR WRITTEN, EXPRESS OR IMPLIED. THE DURATION OF ANY AND ALL WARRANTIES ON THE PRODUCTS DISCUSSED ARE LIMITED TO TWELVE MONTHS. ATI IS NOT RESPONSIBLE IN ANY EVENT FOR DIRECT, SPECIAL, INCIDENTAL OR CONSEQUENTIAL DAMAGES. No ATI dealer, agent, or employee is authorized to make any modification, extension, or addition to this warranty.



