

MAYFAIR ELECTRONICS

PART NO.
151-1262

TITLE: WIRELESS/BLUETOOTH CONTROL SWITCH
w/ CARBON FACE & BILLET BUTTONS

151-1262B: BLUE CARBON
151-1262BK: BLACK CARBON
151-1262BGK: GLOSS BLACK
151-1262R: RED CARBON
151-1262S: SILVER CARBON

www.hardin-marine.com

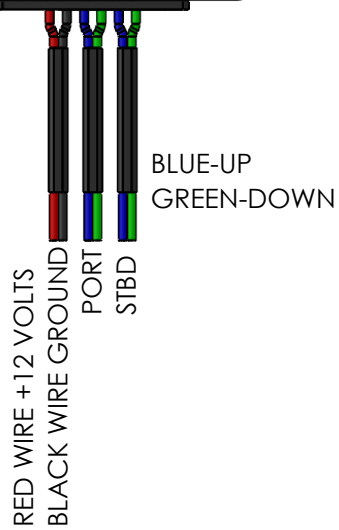
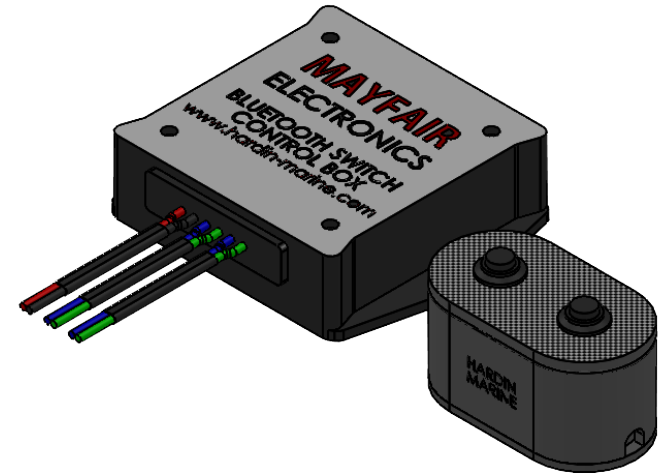
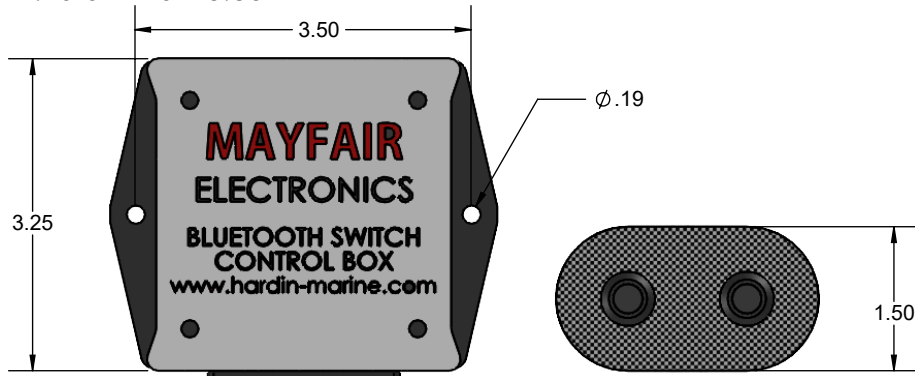

NOTES:

Output is +12 volts with a maximum load of 10 amps. Connect to either the trim switches or trim pump solenoids.

WARNING
DO NOT CONNECT THE OUTPUTS DIRECTLY TO THE TRIM PUMP MOTOR. CONNECT ONLY TO THE SOLENOIDS.

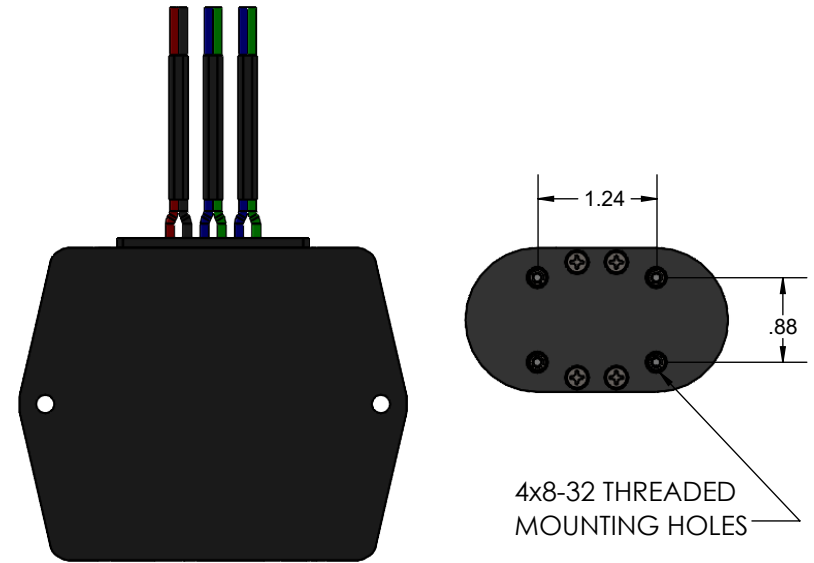
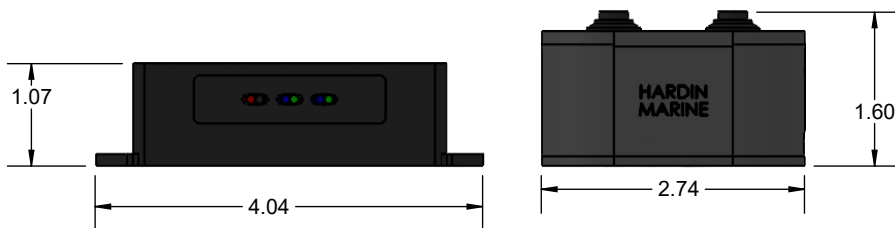

THIS DRAWING IS CONFIDENTIAL AND IS SUPPLIED ON EXPRESS CONDITION THAT IT SHALL NOT BE LENT, COPIED OR DISCLOSED TO ANY OTHER PERSON OR USED FOR ANY OTHER PURPOSE WITHOUT WRITTEN CONSENT OF HARDIN MARINE INC.. BREACH OF THIS CONTRACT WILL HOLD AND IT'S PRINCIPALS LIABLE FOR LOSS AND DAMAGES.

**Remote
Trim
Controller**

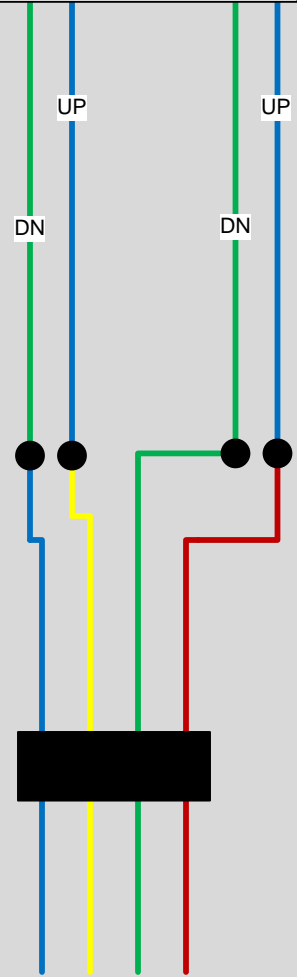
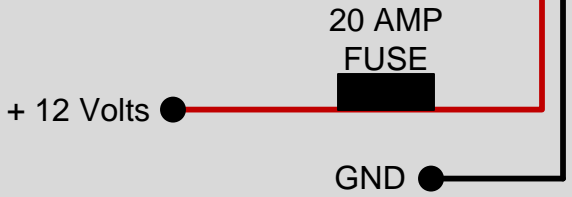

PLACE DIVERTER
TRIM PUMP

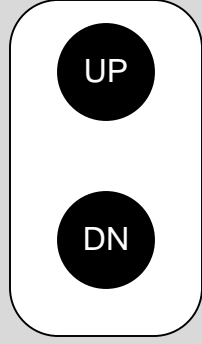

Place Diverter Pump Wiring

--	--	--