

1

BRAVO DRIVE OR TRANSMISSION

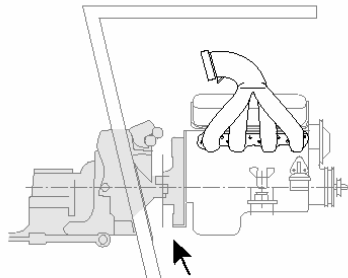

BRAVO DRIVE

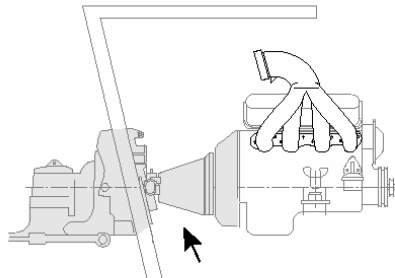

TRANSMISSION

2

TRANSOM TIP, THRU-HULL OR COMPLETELY DRY

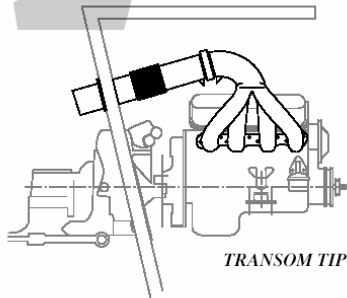

TRANSOM TIP

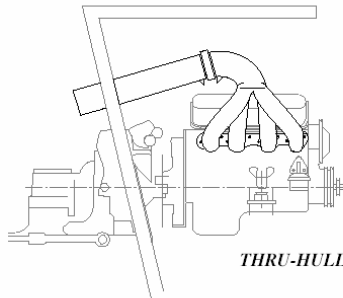

THRU-HULL

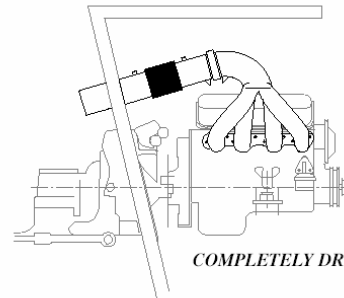

COMPLETELY DRY

See detail on next page.

	DESCRIPTION	ADVANTAGE	DISADVANTAGE
TIP-STYLE	Cooling water and exhaust gasses are mixed together just inside the transom. The Tip-Style tailpipe connects to a single wall transom tip with a rubber hose.	Tip-Style tailpipes are the most common type of tailpipe, usually provided with engine package from OEM. Typically Tip-Style tailpipes are the lowest in price and the quietest of the different styles of tailpipes.	Mixing water close to the motor could result in water reversion in higher horsepower motors.
THRU-HULL	Cooling water and exhaust gasses are mixed together outside the transom. No separate transom tips are needed.	Thru-Hull tailpipes will typically produce more horsepower. Thru-Hull style tailpipes also have less of an opportunity for water reversion.	Exact transom hole measurement are critical for a proper fit.
COMPLETELY DRY	Cooling water and exhaust gasses do not mix. Cooling is routed out a dump hose to the outside of the boat away from the system. Because of metal expansion and contraction a split is applied to the outside tubing. This split is covered by a rubber hose to eliminate any opportunity for metal fatigue.	Virtually eliminate any opportunity for water reversion and produces the highest horsepower.	Require additional plumbing for through hull applications.

COMPLETELY DRY TAILPIPE

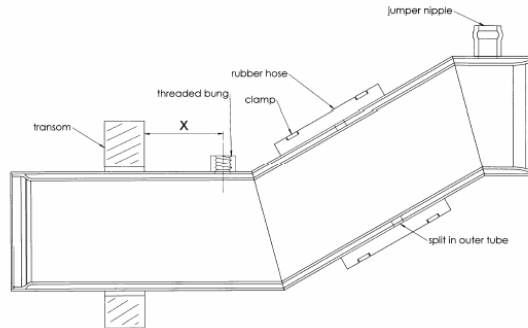

3 PARALLEL VS. PERPENDICULAR

Illustration **A** represents a parallel tailpipe exit. The tailpipe tip is exiting the boat parallel to the crankshaft line. Illustration **B** represents a perpendicular (90° angle) tailpipe exit. The tailpipe tip is exiting the boat perpendicular to the transom angle.

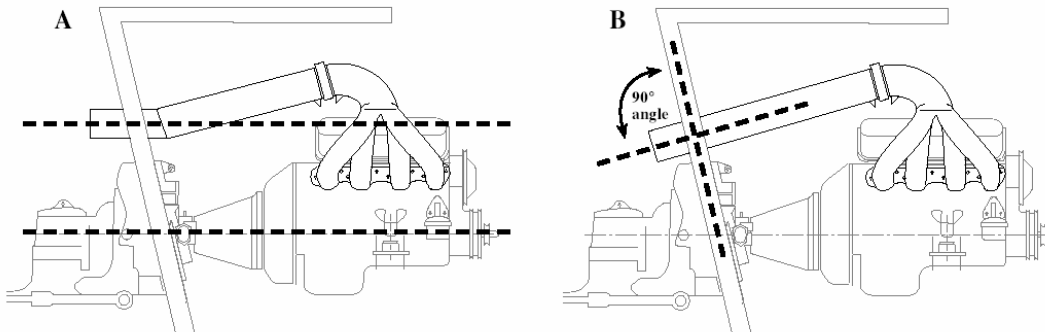

4

STRAIGHT, ONE ANGLE, TWO ANGLE & S-PIPE

STRAIGHT PIPE

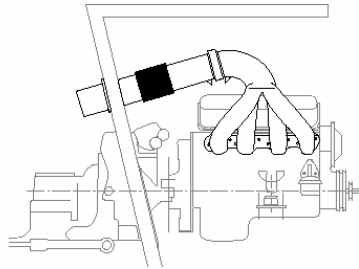

SIDE VIEW

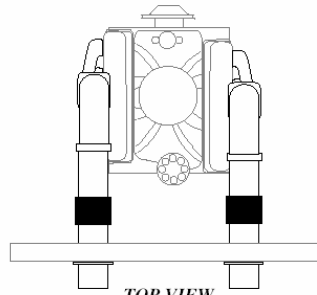

TOP VIEW

ONE ANGLE PIPE

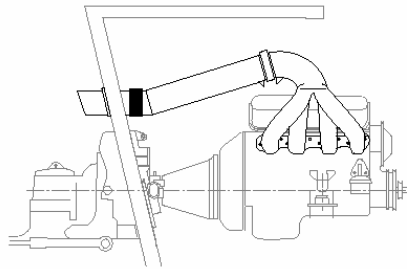

SIDE VIEW

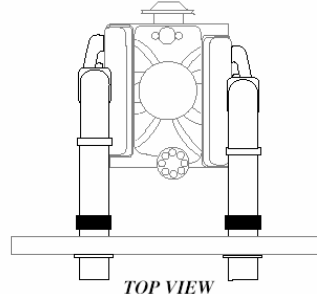

TOP VIEW

TWO ANGLE PIPE & CUSTOM PIPE

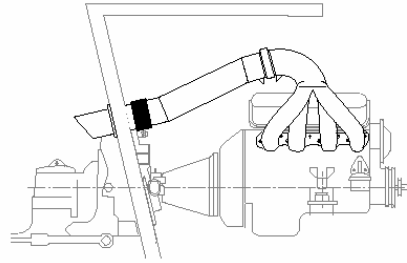

S-PIPE

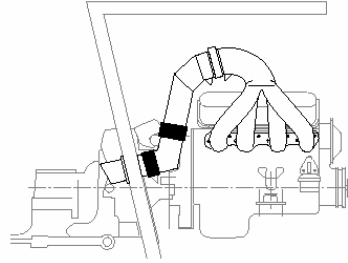

5

OFFSET DIRECTION

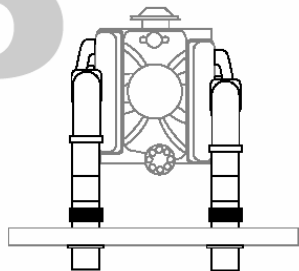

STRAIGHT

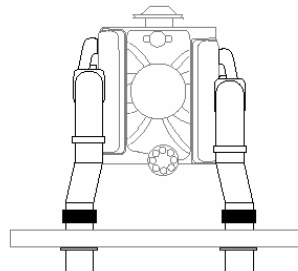

OUTBOARD OFFSET

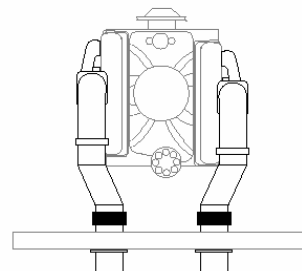

INBOARD OFFSET

HOW TO MEASURE HOLE HEIGHT CMI TAILPIPE MEASUREMENT GUIDE

All vertical dimensions are for standard height manifolds and taken on the outside of the transom with ruler flat against transom. CMI requires precise measurements to ensure system fit. Plus or minus transom measurements indicate minimum and maximum dimensions in which tailpipe transom holes may be specified. Radius angles versus mitered angles will be an additional \$300 charge. See Measurement Guide for instructions to measure tailpipe installation.

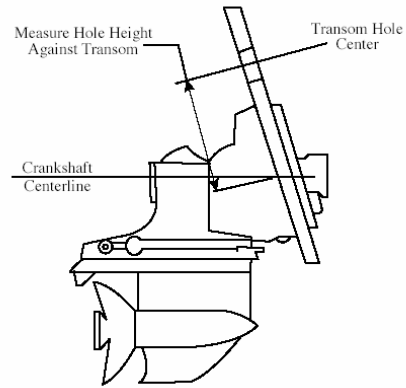
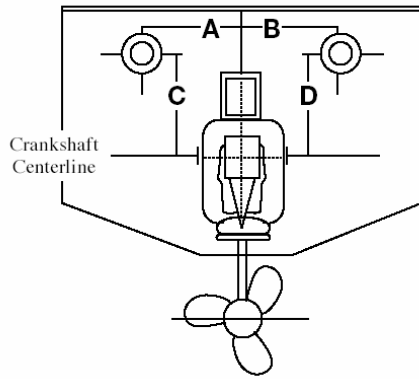

CORRECT MEASUREMENT METHOD



SHOP BUILD INFORMATION SHEET

CMI FORM #1

(Circle each that apply)

HEADERS & TAILPIPES **HEADERS ONLY** **TAILPIPES ONLY** **USE MOCKUP** **DUPLICATE OLD PARTS**

NUMBER OF ENGINES: Single Twin Triple Quad **HULL STYLE:** V-Hull Cat

ENGINE MANUFACTURER: _____

ENGINE HP: _____ EFI Carburetor SC Magnum Bulldog **CID:** _____

ENGINE PLACEMENT: Side by Side Standard Staggered Reverse Staggered Triple 3 Point Stagger Quad

BLOCK HEIGHT: Standard 9.8 Tall Deck 10.2 Super Tall Deck 11.625 MV-10 Other _____

STAGGERED ENGINE HEIGHT: _____ Forward Rear Rise Drop None

HEADS: Cast Iron Cast Aluminum **MACHINED:** Angle Milled Degree _____

HEAD MFG: Stock GM Brodix Dart 360 Dart Pro1 Merlin Big Chief – 14 or 18 Canfield Ilmor Edelbrock Air Flow Research

DRIVES: Bravo XR Bravo One Imco ITS Surface Speed Master# _____ Arneson NXT Other _____

DRIVESHAFT: Yes No

STANDOFF BOXES: Yes No **SETBACK:** _____ **INCHES:** _____ None

HEADERS: E –Top Uni-Top Sport Tube Big E-Top Big Tube MV-10 Mercury 525 / 600 / 700

HEADER STYLE: Downturned Straight **FINISH:** Polish Platinum

DISTRIBUTION TUBE: Rubber Stainless Up Grade Mercury 525 / 600 / 700 Style

PRIMARY SIZES: 1 7/8” 2 1/8” 2 1/4” 2 3/8” **FLANGE:** Standard Edelbrock D-shaped

BRACKETS: Shift Oil IGN EFI Other _____ None

JUMPER NIPPLES: 1” 90 degree 1 1/4” 90 degree 1 3/8” Straight 1 1/8” Straight Mercury 525 / 600 / 700 Restrictor Bungs

JUMPER LOCATION: 12 O’ Clock 2 & 10 Inboard Other _____

CLAMPS: Rope Mercury Flat Flange E-Top Flex Flare Sport Tube / Sweeper Flex Flare Big Tube Flex Big Tube Rope

TAILS: Transom Tip Thru Hull Completely Dry Y-Pipe S-Pipe Rubber Hose

MUFFLERS: Internal Sound Choice AFT Firing Sound Elimination _____ 496 Baffled Tips ST-450 Tips _____ None

TRANSOM THICKNESS: 2” 2 1/8” 2 1/4” 2 1/2” Other _____ **DEGREE:** _____

TRANSOM TAILPIPE ANGLE: Perpendicular to Transom Parallel to Crankshaft

TAILPIPES: Straight 1 Angle (Straight) 2 Angle (Straight) 2 Angle (Offset) S-Pipe (Straight) S-Pipe (Offset)

S – STYLE TAILPIPES: One Piece “S” Two Piece “S” (up charge required for one piece)

RADIUS TAILPIPE ANGLES: Yes No (up charge required)

DUMP: CMI Standard External with NPT Bung Other _____

STEPPED TAILS: Yes No Size: From _____ To _____ (up charge required)

SPECIAL INSTRUCTIONS:

Fax this page to Custom Marine at (920) 722-4530

ALL MEASUREMENTS MUST BE MADE AT THE CRANKSHAFT CENTERLINE

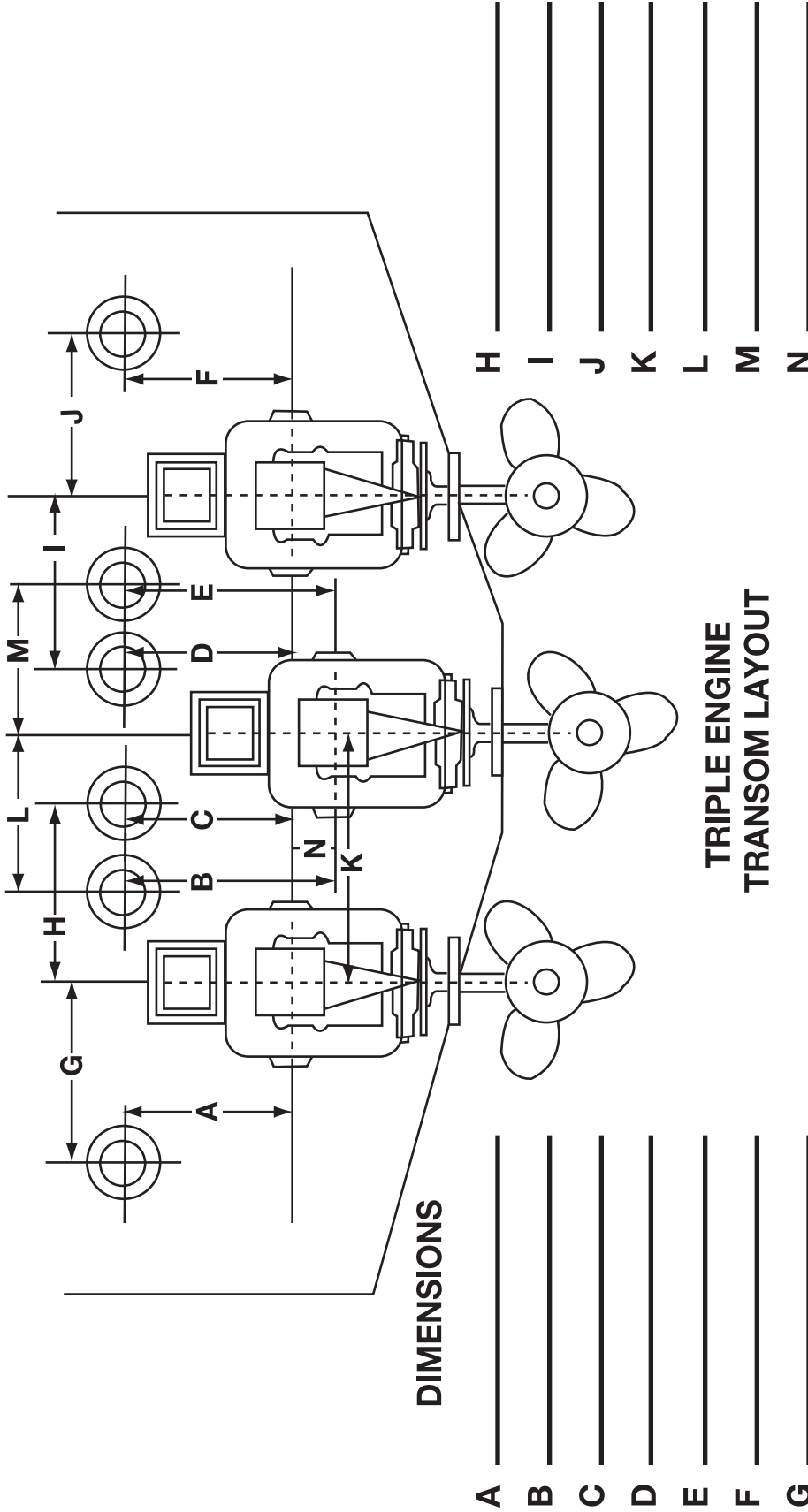

DIMENSIONS

A _____
 B _____
 C _____
 D _____
 E _____
 F _____
 G _____

TRIPLE ENGINE
 TRANSOM LAYOUT

H _____
 I _____
 J _____
 K _____
 L _____
 M _____
 N _____

SIGNATURE _____ DATE _____

FAX THIS PAGE TO CUSTOM MARINE AT (920) 722-4530

ALL MEASUREMENTS MUST BE MADE AT THE CRANKSHAFT CENTERLINE

DIMENSIONS

A _____ BELL HOUSING MOUNTING SURFACE TO BELL HOUSING MOUNTING SURFACE

B _____ BELL HOUSING MOUNTING SURFACE TO INSIDE TRANSOM AT THE CRANKSHAFT CENTER

C _____

D _____

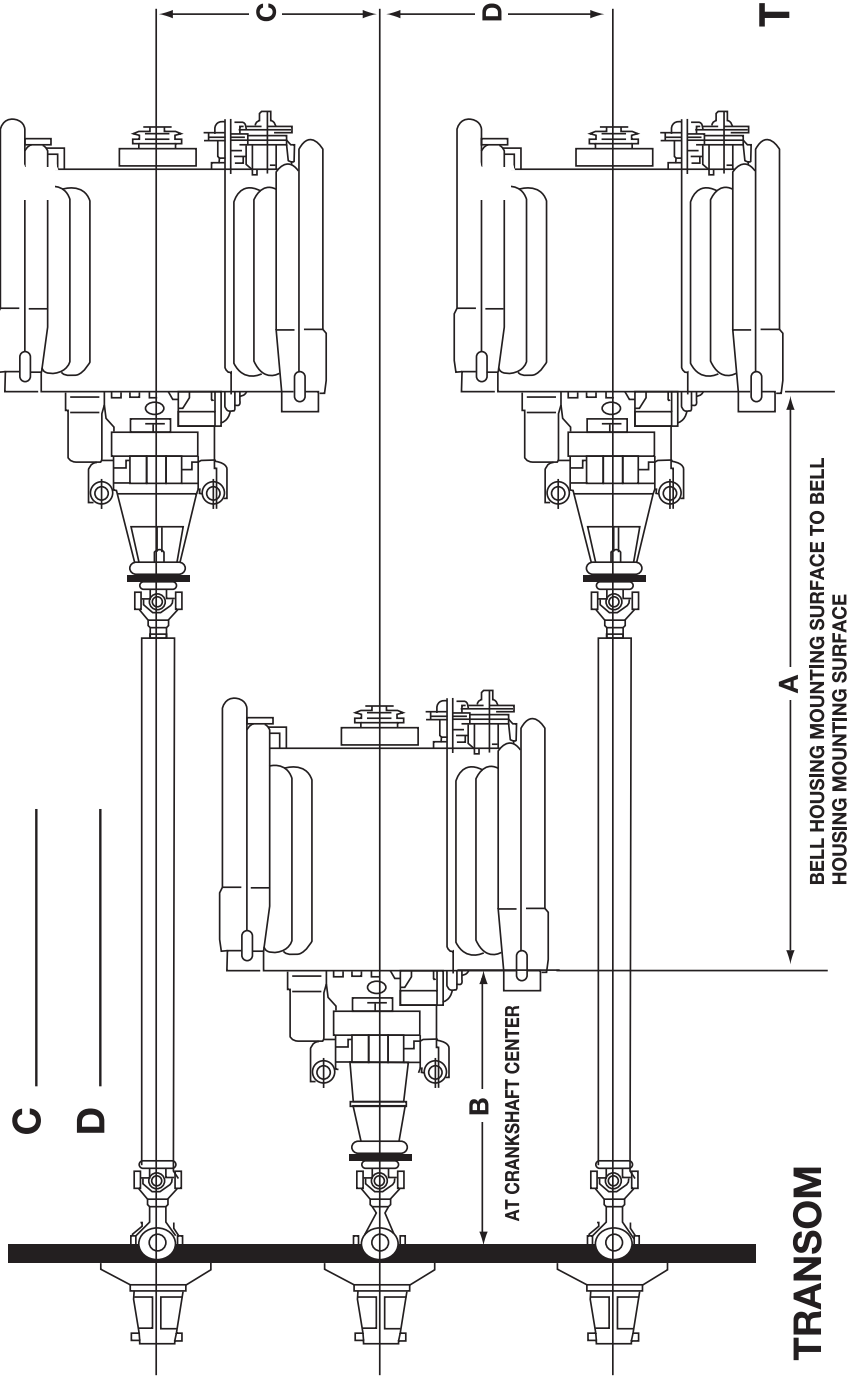

**TRIPLE (REVERSE)
TOP VIEW
MOUNTED ENGINES**

TRANSOM

SIGNATURE _____ DATE _____

FAX THIS PAGE TO CUSTOM MARINE AT (920) 722-4530

ALL MEASUREMENTS MUST BE MADE AT THE CRANKSHAFT CENTERLINE

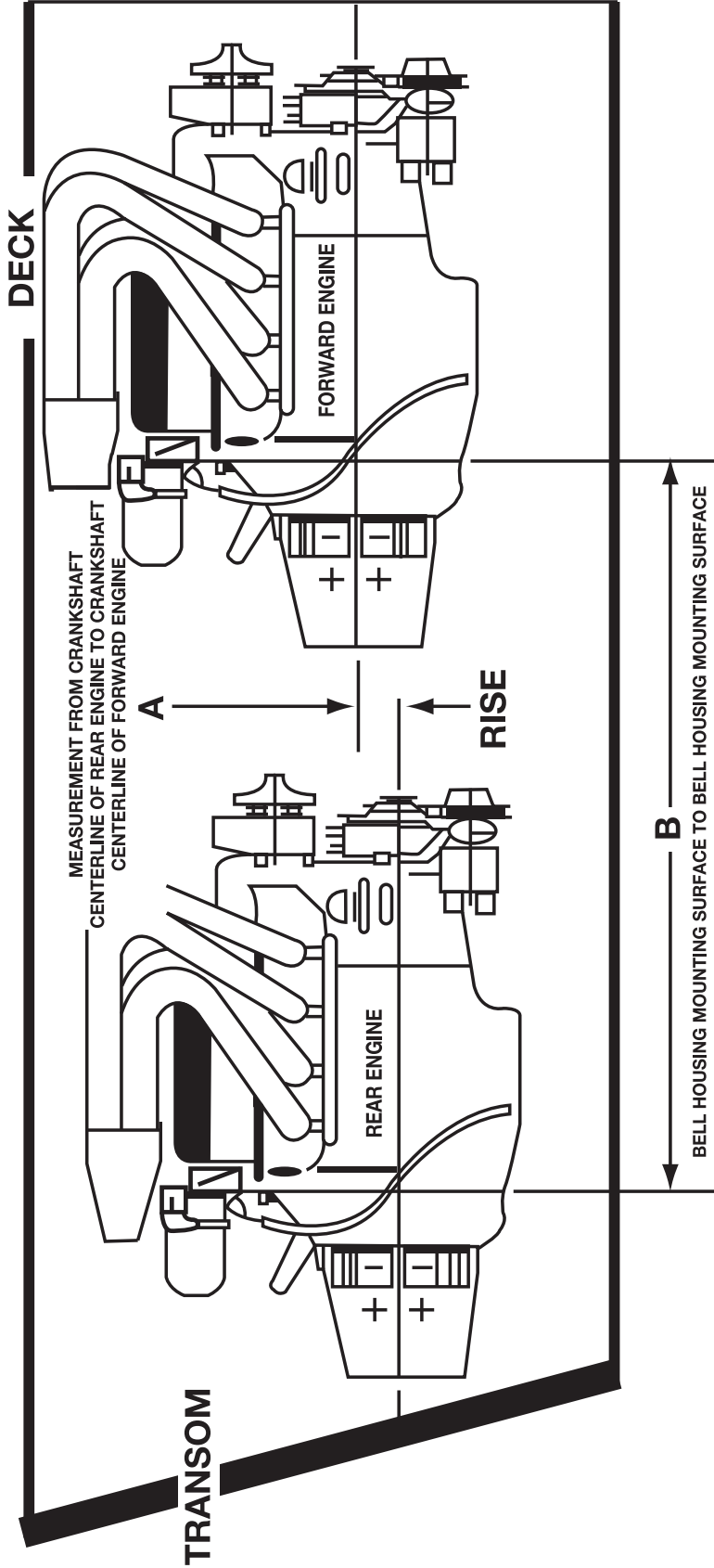

**SIDE VIEW
STAGGER AND TRIPLE SETUP
MOUNTED ENGINES**

DIMENSIONS

A _____ FORWARD ENGINE RISE DIMENSIONS

B _____

SIGNATURE _____ DATE _____

FAX THIS PAGE TO CUSTOM MARINE AT (920) 722-4530

ALL MEASUREMENTS MUST BE MADE AT THE CRANKSHAFT CENTERLINE

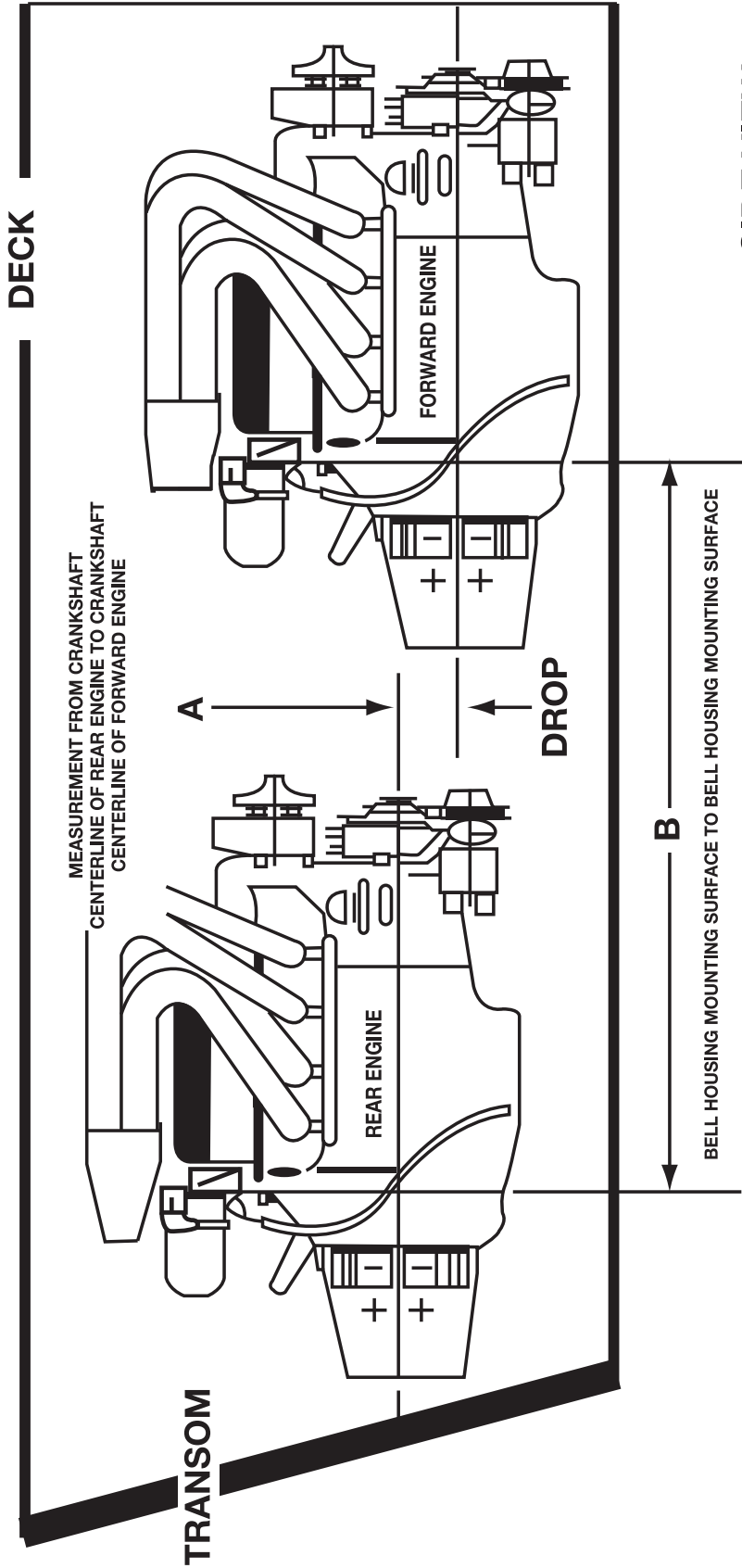

**SIDE VIEW
STAGGER AND TRIPLE SETUP
MOUNTED ENGINES**

DIMENSIONS

A _____ FORWARD ENGINE DROP DIMENSIONS

B _____

SIGNATURE _____ DATE _____

FAX THIS PAGE TO CUSTOM MARINE AT (920) 722-4530

AGREEMENT SIGN-OFF SHEET

TERMS AND CONDITIONS

DEFINITIONS: As used in this document, the term 'Products' shall mean the item(s) offered for sale by Custom Marine Inc (CMI) as part of its regular business. The term 'Seller' shall mean CMI, and the term 'Buyer' shall mean the person or company purchasing Products from CMI.

GOVERNING SALES CONTRACT: These Terms and Conditions constitute the Sales Contract between Buyer and CMI with respect to the Products. No attempted modification or addition to these terms and conditions by Buyer is acceptable to or binding upon CMI and CMI hereby expressly rejects any such attempted modification or addition.

PRICING: All CMI listed prices are stated in U.S. dollars, f.o.b. Neenah, WI, and are subject to change without notice. Catalog prices do not include any crating or shipping costs. CMI is not responsible for printing errors. Freight charges included in any quote are subject to adjustment for actual cost incurred by CMI. For Products being shipped outside the continental limits of the United States, all expenses and fees relating to export/import shall be the responsibility of the Buyer. In addition to the purchase price, the Buyer agrees to reimburse CMI for any cost incurred as a result of:

Changes in the Product or delays in delivery as requested by the Buyer.

Delays in delivery because the Buyer failed to provide requested information.

Changes in the laws, rules or regulations that apply to the Products, after the date of quotation.

PAYMENTTERMS: All payments shall be in U.S. DOLLARS, without offset, back charge, retention or withholding of any kind. Unless otherwise agreed to, all invoices are immediately due and payable upon delivery of Products. Unless otherwise agreed to, all CMI orders are shipped C.O.D. (cashiers or certified check), unless use of an approved major credit card, or prepayment is arranged. Special custom orders require a 50% deposit prior to manufacturing the Product. Minimum order requirement is \$50, not including shipping charges. Any orders totaling less than \$150, may be assessed an additional \$50 service charge and any orders totaling more than \$150 but less than \$250 may be assessed an additional \$25 service charge; back orders excluded. Buyer shall pay to CMI all costs of collection incurred by CMI to collect any delinquent payment owed by Buyer, including court costs, expenses and attorney's fees.

SHIPPING: All CMI shipments will be made UPS Ground Collect, unless Buyer specifies otherwise. All shipments will be fully insured, unless declined in writing by the Buyer. If insurance is declined, the entire order must be prepaid before shipping. Any claims for lost or damaged goods must be made directly to the specific carrier. All shipping dates are estimates only, and are subject to change, based upon, but not limited to, production scheduling and material availability. CMI will make commercially reasonable efforts to meet any requested delivery date, but CMI shall not assume any liability if the date is missed. IN NO EVENT SHALL CMI BE LIABLE FOR ANY DAMAGES OR CLAIMS FOR LOSS OF USE OR FOR ANY OTHER DIRECT OR CONSEQUENTIAL DAMAGES RESULTING FROM ANY DELAY IN DELIVERY REGARDLESS OF THE REASON(S). Any Buyer who refuses delivery of any order, excluding damaged shipments, shall be required to pay the additional return freight charges and/or a 15% restocking fee. These charges must be paid in full before any future orders will be shipped. Products shall be inspected upon receipt. Failure of the Buyer to notify CMI of any defects within 30 days, or to permit CMI a reasonable opportunity to correct any defects, shall constitute acceptance of the Product.

SHIPPING & HANDLING CHARGES: For orders less than \$150.00, a shipping and handling charge of \$50 will be assessed. For orders between \$150 and \$250 a shipping and handling charge of \$25 will be assessed. Drop shipped orders are subject to additional surcharges.

RETURN AUTHORIZATION: For a 90 day period, subsequent to the original purchase date, a Buyer may call CMI to request a written authorization to return stock items. The Buyer must provide CMI with the invoice number, date and reason for returning the items. Unless otherwise agreed to, only the original Buyer will be allowed to return CMI Products for credit. Upon CMI approval, the Buyer will receive authorization for the prepaid freight return of the Product(s) Buyer desires to return to CMI. After inspection to verify that the items are in a new, unused, salable condition, CMI will issue a credit to Buyer, less a 15% restocking fee, based on the original purchase price paid.

(continued)



ISO 9000:2000 CERTIFIED

P: 920-722-7084 | F: 920-722-4530 | custommarine.com

#1 CHOICE IN RACE BOATS, #1 CHOICE IN YOUR BOAT!

Copyright 2010 © Custom Marine Inc.

AGREEMENT SIGN-OFF SHEET

(continued)

All custom or special order items will not be accepted for return. The Product needs to be shipped to the following address:

Custom Marine Inc.
1315 County Road G
Neeah, WI 54956

CANCELLATION: Buyer can not terminate, cancel or modify any order, in whole or in part, except with CMI's written consent and then only upon terms and conditions which shall include protection of CMI against all loss in relation to such termination, cancellation or modification.

FORCE MAJEURE: CMI shall not be liable for any failure to perform hereunder if such failure is caused directly or indirectly, in whole or in part, by fires, floods and other acts of God; war, terrorism, or other hostilities; strikes or other labor disputes; work stoppages; accidents and casualties; inability to procure supplies, fuel and raw materials; delays in transportation, restrictions or regulations imposed by any governmental authority; quarantine or embargo; disease, illness, outbreak or plague including, without limitation, hoof-and-mouth disease; or any other cause beyond CMI's control, whether of the kind enumerated or otherwise.

LIMITATION ON LIABILITY: IN NO EVENT SHALL CMI BE LIABLE TO BUYER OR ANY THIRD PARTY FOR LOST PROFITS, INDIRECT, SPECIAL, PUNITIVE OR CONSEQUENTIAL DAMAGES, OR OTHER SIMILAR DAMAGES, WHETHER BASED IN CONTRACT, TORT (INCLUDING NEGLIGENCE), STRICT LIABILITY OR OTHERWISE, UNLESS CMI'S DIRECT ACTS RESULT IN THE INJURY TO, OR DEATH OF A PERSON. UNDER NO CIRCUMSTANCES SHALL CMI'S LIABILITY TO BUYER OR ANY THIRD PARTY FOR ANY CLAIM, LOSS OR DAMAGE WHATSOEVER EXCEED THE PRICE OF THE SPECIFIC PRODUCTS WHICH GAVE RISE TO SUCH CLAIM, LOSS OR DAMAGE.

GOVERNING LAW AND VENUE: This Sales Contract shall be construed under and governed by the laws of the State of Wisconsin. Any dispute, claim or litigation concerning or related to this Sales Contract (or the relations between CMI and the Buyer) shall be venued in a state or federal court situated in the State of Wisconsin and Buyer shall not remove any such litigation to another jurisdiction.

WARRANTY: CMI warrants standard Elbow Top headers for a period of two years from the date of manufacture. All other headers and exhaust components are warranted for a period of one year. The limited warranty covers defects in material and workmanship, to the original buyer only. CMI will, at its option, replace or repair the product which, in the judgment of CMI, is defective. The product will be shipped at the buyer's expense. CMI shall not be liable for any cost of removal or installation. This warranty shall not apply if the product has been

misused, abused, altered, neglected, improperly installed, or if repair work was performed by anyone other than CMI. This warranty does not apply to any product used for racing or military applications. CMI reserves the right to improve its products through changes in design and materials, without obligation to incorporate such changes in product of prior manufacture. CMI reserves the right to make these changes at any time, without obligation or liability, to owners of products of prior manufacture. CMI shall not be held responsible for any violation of state or local ordinances, pertaining to the use of its products.

THIS LIMITED WARRANTY IS GIVEN IN LIEU OF ALL OTHER WARRANTIES, EXPRESS OR IMPLIED, ARISING UNDER THIS SALES CONTRACT OR BY LAW. CMI MAKES NO WARRANTIES EXCEPT THOSE SPECIFICALLY SET FORTH HEREIN.

IN NO EVENT SHALL CMI BE LIABLE TO BUYER OR ANY THIRD PARTY FOR LOST PROFITS, INDIRECT, SPECIAL, PUNITIVE OR CONSEQUENTIAL DAMAGES, OR OTHER SIMILAR DAMAGES, WHETHER BASED IN CONTRACT, TORT (INCLUDING NEGLIGENCE), STRICT LIABILITY OR OTHERWISE, UNLESS CMI'S DIRECT ACTS RESULT IN THE INJURY TO, OR DEATH OF A PERSON. UNDER NO CIRCUMSTANCES SHALL CMI'S LIABILITY TO BUYER OR ANY THIRD PARTY FOR ANY CLAIM, LOSS OR DAMAGE WHATSOEVER EXCEED THE PRICE OF THE SPECIFIC GOODS WHICH GAVE RISE TO SUCH CLAIM, LOSS OR DAMAGE.

We can build a tailpipe or custom header only as good as the template or accuracy of your measurements. A small error in the mockup or measurement can result in a huge fit issue. Take your time producing the mock ups and taking the measurements. We can only build tailpipes or custom headers as good as the mockups and dimensions that we are given.

By signing this form, I agree to all of the above guidelines and also agree that I have taken the proper amount of time to produce accurate and complete mockups, accurately completed the dimension sheets, and assume responsibility for any error caused by the inaccuracy of the template or dimensions given to Custom Marine Inc. Custom Marine will be responsible to insure the parts are built to the mockups or dimension sheets supplied.

Signature _____

Print Name _____

Today's Date _____



ISO 9000:2000 CERTIFIED

P: 920-722-7084 | F: 920-722-4530 | custommarine.com

#1 CHOICE IN RACE BOATS, #1 CHOICE IN YOUR BOAT!

Copyright 2010 © Custom Marine Inc.