

OWNER'S MANUAL

'94-'97 502/454 MAGNUM EFI/MPI
M-1/M-1SC INTERCOOLED SYSTEM

PROCHARGER[®]
Marine

Centrifugal Supercharger Systems

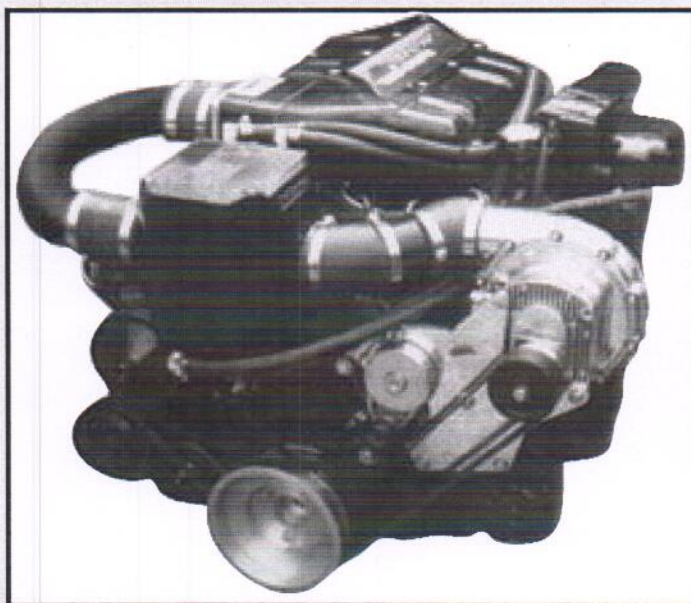

The Intercooled Supercharging Experts![®]



ACCESSIBLE TECHNOLOGIES, INC.
© 2006 ATI, ALL RIGHTS RESERVED
1MB181-NN



INSTALLATION OVERVIEW

Congratulations on the purchase of your ProCharger® centrifugal supercharger system, and welcome to the world of centrifugal supercharging. You are now the owner of the most powerful and reliable supercharger system available, and the latest technology in supercharging!

This Owner's Manual contains the following sections:

- **INTRODUCTION**
- **INSTALLATION INSTRUCTIONS**
- **OPERATION AND MAINTENANCE**
- **WARRANTY**

If you are performing the installation of this system and this is your first ProCharger installation, you will likely benefit from reading the entire installation instructions prior to proceeding, and then reviewing each section as you go. If you are familiar with supercharging, remember that centrifugal supercharging is different from roots supercharging, and the same rules do not apply, primarily due to the unparalleled efficiency of the ProCharger, and the vastly cooler intake temperatures that result, especially when intercooled.

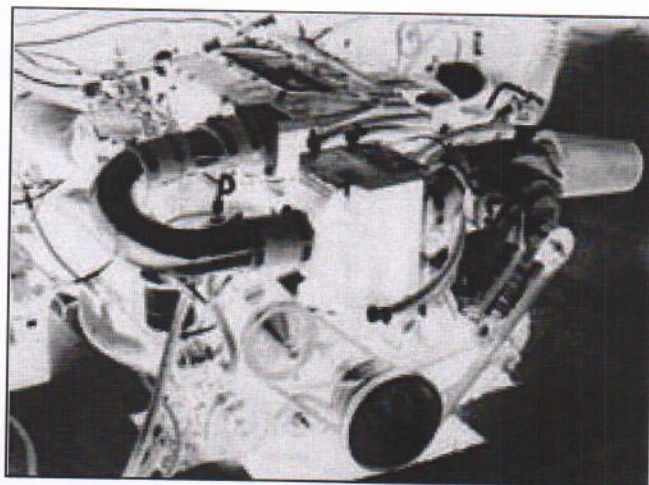

- A. OIL DRAIN SETUP**
- B. ENGINE PREPARATION**
- C. OIL FEED SETUP**
- D. ENGINE ACCESSORY AND PROCHARGER INSTALLATION**
- E. AIR INLET AND INTERCOOLER TUBING INSTALLATION**
- F. WATER LINE INSTALLATION**
- G. FUEL SYSTEM INSTALLATION**
- H. INSTALLATION REVIEW AND SAFETY CHECK**
- I. GENERAL TUNING AND THEORY**
- J. OPERATION AND MAINTENANCE, SPECIAL NOTES FOR SC APPLICATIONS**



IMPORTANT INFORMATION FOR RELIABLE OPERATION!

USE MINIMUM 91 OCTANE FUEL AT ALL TIMES

MERCUISER EFI/MPI REV LIMITER LIMITS RPM BY CUTTING OFF FUEL, WHICH CAN CAUSE A DANGEROUS LEAN CONDITION. ENSURE THAT BOAT IS PROPPED SO THAT MAXIMUM RPM IS BELOW FACTORY REV LIMITER. REPEATEDLY BUMPING/RIDING REV LIMITER CAN RESULT IN SERIOUS ENGINE DAMAGE.

Torque Specification Chart	 Grade 5 Torque (lb. ft.)			 Grade 8 Torque (lb.ft.)		
	Thread Size					
1/4-20	11	8	7	16	12	10
1/4-26	13	10	8	18	14	11
5/16-18	23	17	14	33	25	20
5/16-24	26	19	15	36	27	22
3/8-16	41	31	25	58	44	35
3/8-24	47	35	28	66	49	39
7/16-14	66	49	40	93	70	56
7/16-20	74	55	44	104	78	62
1/2-13	101	75	60	142	106	85
1/2-20	113	85	68	160	120	96

INSTALLATION OVERVIEW

For best results we recommend that you review the installation instructions beforehand, and follow the installation instructions closely and in sequence. A detailed packing list is provided (inside box) to help you identify the components of your ProCharger Marine system. The following tools will be required to install your ProCharger Marine supercharger system:

REQUIRED TOOLS & SUPPLIES

- 3/8" SOCKET SET (STANDARD & METRIC)
- 1/2" SOCKET SET (STANDARD & METRIC)
- SCREWDRIVER SET
- OPEN END WRENCH SET (STANDARD & METRIC)
- RAZOR BLADE OR CARPET KNIFE
- ADJUSTABLE WRENCH
- NUT DRIVER SET
- 8 SPARK PLUGS**
- SPARK PLUG SOCKET**
- OIL FILTER¹
- 9 QUARTS ENGINE OIL (STRAIGHT 40W AS RECOMMENDED BY **MERCUISER**)¹
- HEAVY GREASE*¹
- SILICONE SEALER*¹
- LARGE HAMMER*¹
- 3/8" NPT TAP*¹
- 9/16" TAPERED PUNCH*¹
- CENTER PUNCH*¹
- PLIER SET
- WIRE CUTTERS
- OIL FILTER WRENCH¹

You should also have the following gauges available to properly check the finished installation and monitor your vessel's performance (especially for high performance applications):

- boost/vacuum gauge (plumbed to intake manifold)
- fuel pressure gauge (0-100 psi) (plumbed to ATI fuel pressure regulator)

Both gauges should be of a type that can be read from the cockpit while performing a W.O.T. performance test. Cockpit-mounted gauges are preferable, although use of a shop fuel pressure gauge (which has a hose long enough to be read during testing) is an option.

The motor on which the ProCharger is installed should have stock compression. If your engine has been modified in any way, please check with ATI or your dealer before proceeding. This supercharger system is intended for use on strong, well maintained engines. Installation on a worn or troublesome engine should be reconsidered. **Accessible Technologies is not responsible for damage to an engine.**



Warning: Motor and propeller should be configured so that maximum speed does not exceed boat manufacturer's recommendations for your hull.

Note: There are minor variations in Mercruiser motors across model years (such as water hose routing for coolers) which may not *specifically* be addressed in these installation instructions. Please contact an ATI service technician should you have any questions.

* if oil pan does not already have oil return fitting

**if current plugs have more than 100 hours, or are more than 1 yr old

¹Not required for Self Contained (SC) Applications

REVISED 03-09-01

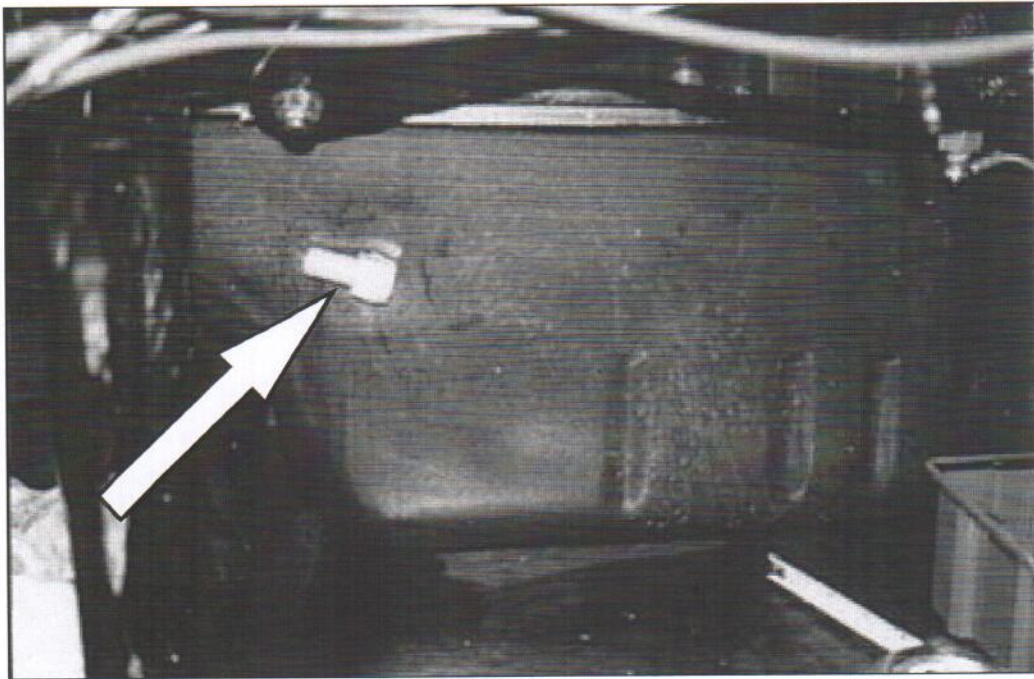

FIGURE A1

**OIL DRAIN FITTING LOCATION AND ORIENTATION
FITTING SHOULD POINT FORWARD, ANGLED SLIGHTLY UPWARD**

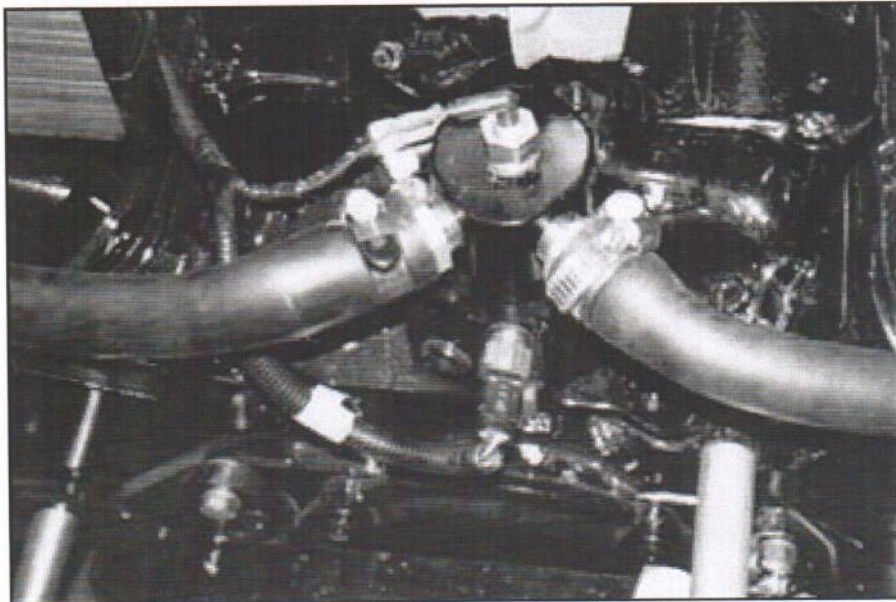

FIGURE B1

THERMOSTAT HOUSING INSTALLATION

INSTALLATION INSTRUCTIONS

A. OIL DRAIN SETUP (OMIT ON SC SYSTEMS)

Completion of this section will establish a fitting for the oil return line, which drains oil from the ProCharger into the engine oil pan

Description and Operation

The main components consist of the oil drain fitting and oil return line. The oil return line is routed from the ProCharger to the oil pan. The drain fitting is installed in the oil pan via either a stock threaded hole or one that must be created. **This is a gravity feed system; the oil return line must be kink free and downhill the entire length, and should drain into the pan above the oil level line.**

Prior to performing the following steps, you should remove stock hardware/accessories as needed to gain access to the port side of the oil pan. Note 1997 & newer: Before re-installing fuel pump/cooler assembly, see para. G. regarding modifications to this assembly.

Pre-1996 motors

1. Remove the 3/8" NPT plug located in the port side of the engine oil pan. (see figure A1)
2. Using silicon or hydraulic sealer, Install supplied 3/8" NPT- 1/2 " barb 90° elbow such that it faces forward and slightly up.

1996 and newer motors

1. Punch (Don't drill; punching produces no shavings and leaves a lip for threading) a small pilot hole 1" behind the fourth bolt hole from the front on the port side of the pan and 3" down from the pan flange. Stepping up punch sizes sequentially, enlarge pilot hole to approximately 9/16". Use as short of punch as possible (approx. 1" penetration). For offshore engine mounts: punch and tap the drain hole 1/2" in front of second oil pan bolt and 2 1/2" down from the flange.
2. Pack a 3/8" NPT tap with grease and tap hole. (FYI: 3/8" NPT refers to the pipe's inner diameter. Wipe grease and foreign matter from hole.
3. Using silicone sealer, install the supplied oil return fitting into the pan.
4. Attach the oil return line to the fitting and secure with clamp. Perform an oil and filter change at this point. After initially draining the oil, pour approximately 1/2 quart of oil down the drain line to flush any residue from inside of pan, then continue with oil change normally.

B. ENGINE PREPARATION

Completion of this section will configure the Mercruiser motor for installation of the ProCharger system components.

1. Remove all engine accessories from front of motor except the harmonic balancer and seawater pump (water pump, power steering pump, alternator, and crank pulley). Note: When removing power steering pump, be sure to retain the shims on the back studs of the pump.
2. Disconnect water lines attached to the thermostat housing assembly. Remove the thermostat housing assembly from the top front of the intake manifold.
3. Remove the brass fitting from the front (facing forward) of the intake manifold. Remove the 1/2" NPT plug from the top of the intake manifold adjacent to the thermostat inlet. Install this plug into the hole in front of intake manifold previously occupied by fitting. Install the supplied 1/2" MPT to 3/8" FPT bushing into the hole adjacent to the thermostat housing. Install overheat warning sending unit from factory thermostat housing into bushing.

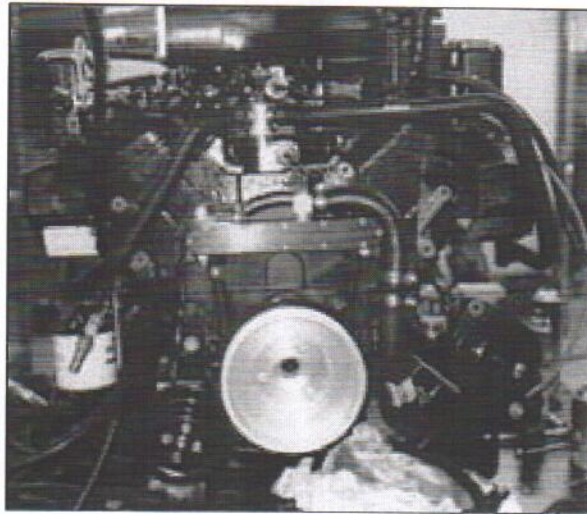

FIGURE B2
MERCUISER EFI MOTOR IN MID-INSTALL

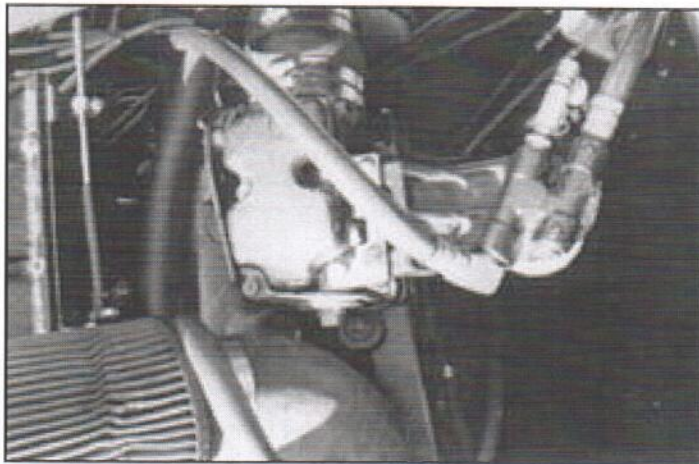
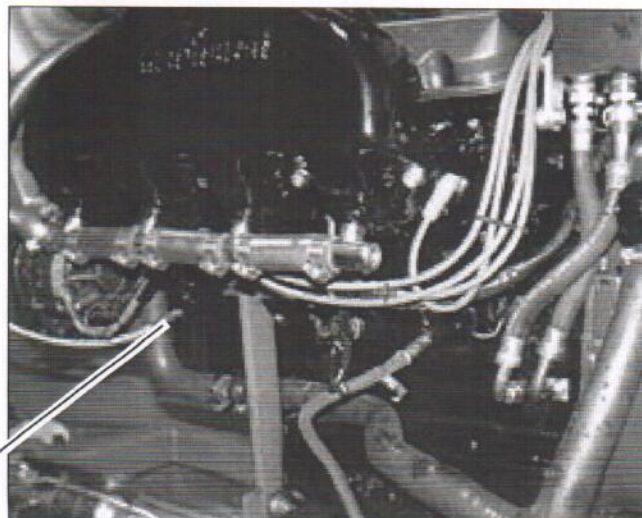

FIGURE C1
OIL FILTER BRACKET INSTALLATION



Oil feed line
(Port side)

FIGURE C2
OIL FEED LOCATION

4. Remove the stock thermostat and housing and replace with ATI supplied housing. Do not install a thermostat.
5. Install supplied crossover tube between the two water pump ports using supplied gaskets, 3/8" lockwashers, and 3/8"x 1" bolts. The center fitting on the tube should face up and to the port side of the engine.
6. If necessary, remove fittings from top front of exhaust manifolds. Install supplied 3/4" NPT plugs.
7. 1996 and newer motors will have a separate oil cooler mounted vertically on the front of the motor. This oil cooler will need to be relocated back near the lower port side of the motor upstream of the power steering cooler as on pre-'96 motors. Remove the two oil fittings from the oil cooler body. Remove the cooler from the water hoses running up the front of the motor.
8. Remove the water hoses from the front and back of the power steering cooler. Supplied with the ProCharger system is a 1 1/4" rubber hose with two bends. Cut the longer end approximately 3" after it makes the bend. From the remaining section, cut a short piece 2-3" long. Using this section and two hose clamps, attach the discharge end of the oil cooler to the inlet end of the power steering cooler.
9. Cut the hose from the seawater pump (originally running to the back of the power steering cooler) just upstream of the 180° bend. Using the supplied straight metal tube and two hose clamps, extend the hose so that it runs back and up to the inlet of the oil cooler. Clamp the hose to the oil cooler.
10. Clamp the 1 1/4" rubber extended 90° elbow cut out in step 8 between the discharge of the power steering cooler and the lower fitting on the crossover tube installed in step 5.
11. Install the supplied 2 piece crankshaft pulley assembly. **Note: 12 rib crank pulley requires use of a supplied round shim (.125), while 8 rib crank pulley does not.** If installing a 12 rib crank pulley, be sure the .125 shim is between the triple-vee pulley and the 12 rib crank pulley.
12. For '96 and older motors only, there is a series of green-yellow-colored rubber lines routed between the manifold, fuel pump and fuel reservoir attached to the manifold. Remove these vacuum lines from the motor. Plug the port on the manifold with supplied vacuum cap and clamp securely.
13. At the front of the upper manifold facing down is a 90° fitting attached to the PCV hose. Remove the hose from the fitting. This hose will be routed to the air filter when installed in section E. Remove the fitting from the manifold. Install the provided 1/4" MPT brass plug.

C. OIL FEED SETUP (OMIT ON SC SYSTEMS)

Completion of this section will allow establishment of an oil feed line from the engine to the ProCharger for oil mist lubrication of bearings and gears.

Description and Operation

The main components consist of the oil feed fittings and oil feed line. The oil feed fitting is installed in the vacant oil galley port located near the front of the motor, on the port side, and provides an oil supply port for the feed line. The oil supply at this location is just downstream of the oil filter. The oil supply is used to supply filtered, high pressure oil to the ProCharger bearings and gears.

1. Remove the oil lines from the oil filter housing. Remove the oil filter housing from the exhaust manifold. Attach the supplied oil filter bracket to the port side outboard exhaust riser bolts. Attach the oil filter housing to the bracket with the tabs on the underside of the bracket. See Figure C1. Pull the oil lines out from beside the computer box. Reroute the lines back up to the relocated oil

**FIGURE D1
ALTERNATOR BRACKET ORIENTATION**

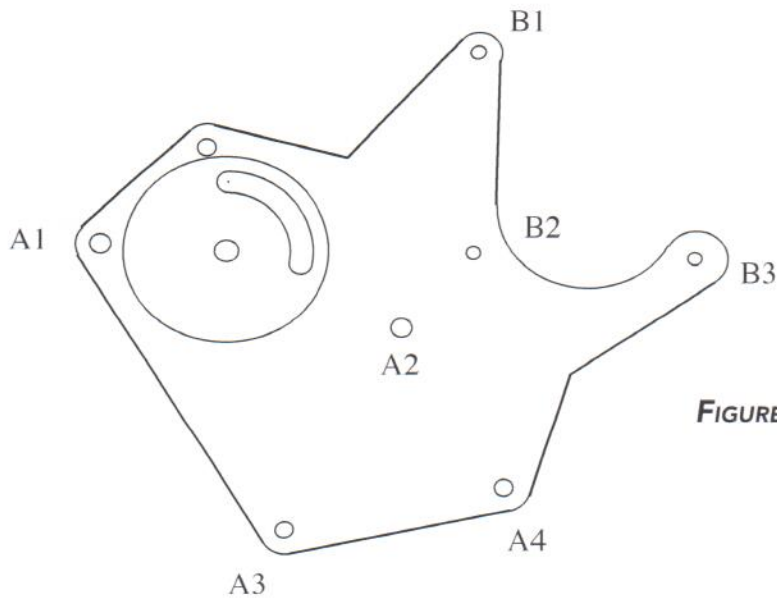
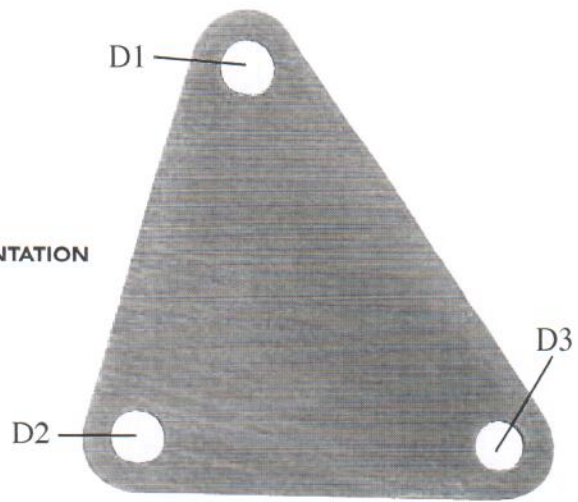

M1 BRACKET

FIGURE D2

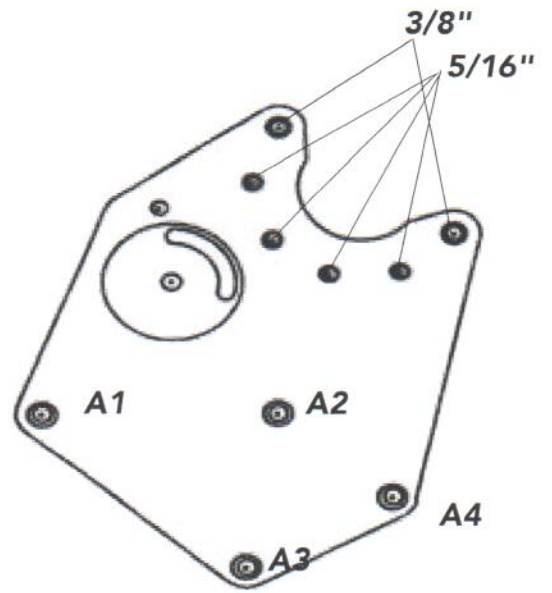

SC BRACKET

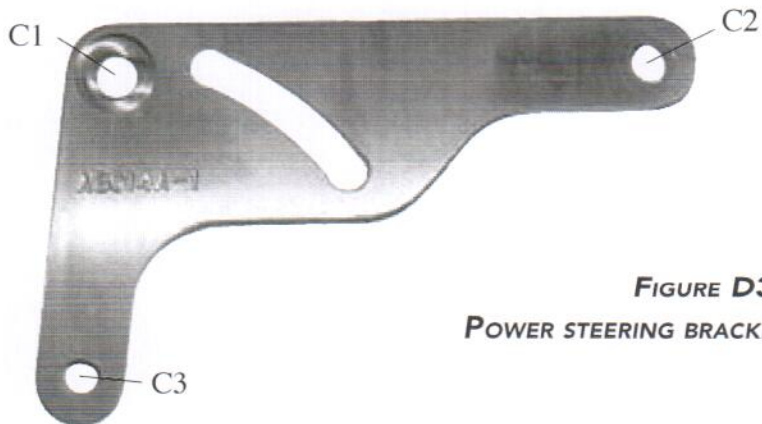

**FIGURE D3
POWER STEERING BRACKET ORIENTATION**

filter housing and securely reattach to the aft/back ports on the oil filter housing; it will be necessary to relocate the plugs in the housing. **Note:** twin engine applications may require purchase of optional transom-mount hardware, due to the lack of side clearance.

2. On the port side of the motor, locate the forwardmost plug (near the front of the motor) in the oil galley. Remove the plug and install the supplied 1/4" MPT - 4 fitting into the port. See Figure C2.
3. Connect the oil feed line to the bushing. **Do not use Teflon™ tape or sealant on the fitting**, as this could block the ProCharger oil inlet and damage the precision bearings inside the ProCharger, voiding your warranty.

D. ENGINE ACCESSORIES AND PROCHARGER INSTALLATION

In this section you will install the ProCharger and supplied air filter, and connect all related oil lines and air hoses.

Description and Operation

The main components of the ProCharger and mounting hardware are the ProCharger, main bracket/tensioner assembly, alternator bracket, and power steering bracket. The ProCharger is a gear-driven centrifugal compressor, driven by an 8 or 12 rib serpentine belt. It utilizes a billet aluminum impeller, super precision bearings and carburized gears. The impeller speed is dictated by engine rpm, crank pulley-to-driven pulley ratio and the final internal gear ratio (M1 = 3.05:1 ; M2 = 4.4:1, M1-SC=4.08:1). As engine speed is increased both airflow and boost (resulting from engine back-pressure) are increased. The quoted boost level for a pulley assumes operation slightly below the engine redline. The mounting brackets are flat billet aluminum types which utilize a series of spacers to properly position the ProCharger and alternator, and relocate the power steering pump.

1. Remove the stud from the starboard head in the upper outermost bolt hole.
2. On the port side, bolt the supplied triangular shaped alternator bracket to the head using the lowermost head bolt hole and hole D2 (from figure D1) with the 7/16 x 1" bolt. The bracket should be oriented so that hole D1 matches up with the upper head bolt hole and the 3/8" hole (D3) sits in the lower of the two positions as shown in figures D4 and D5.
3. Bolt the ProCharger main bracket to the motor using bracket holes A2 and A3 (from figure D2). Hole A3 uses the 4 1/4" spacer and a 3/8" x 5.5" (3/8" x 5" on SC system) bolt. Hole A2 uses the 3 3/4" spacer and a 7/16" x 5.5" (7/16" x 5" on SC system) bolt which runs through the bracket, the spacer, and then hole D1 on the alternator bracket.

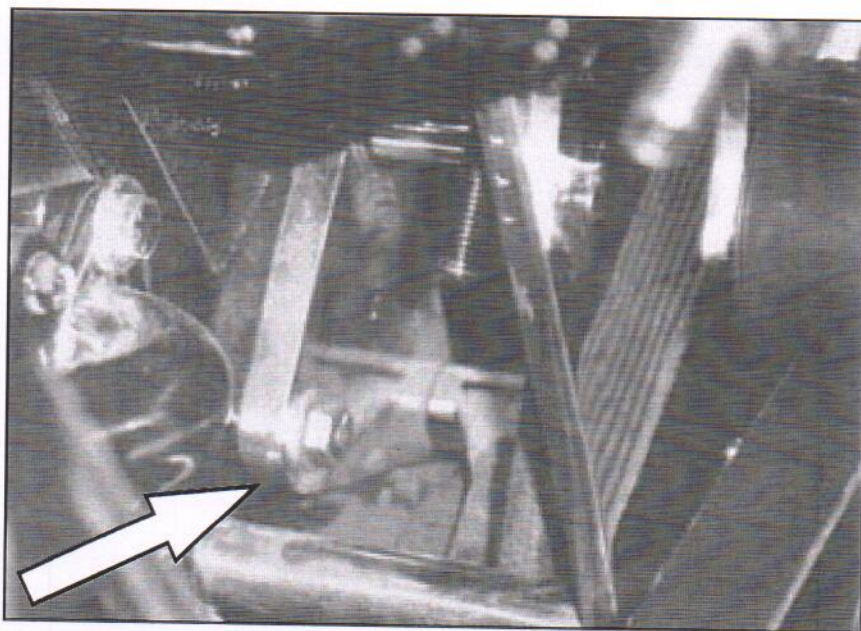

FIGURE D4

THE ALTERNATOR SUPPORT BRACKET MOUNTED TO HEAD, WITH ALTERNATOR AND MAIN BRACKET SPACER ATTACHED

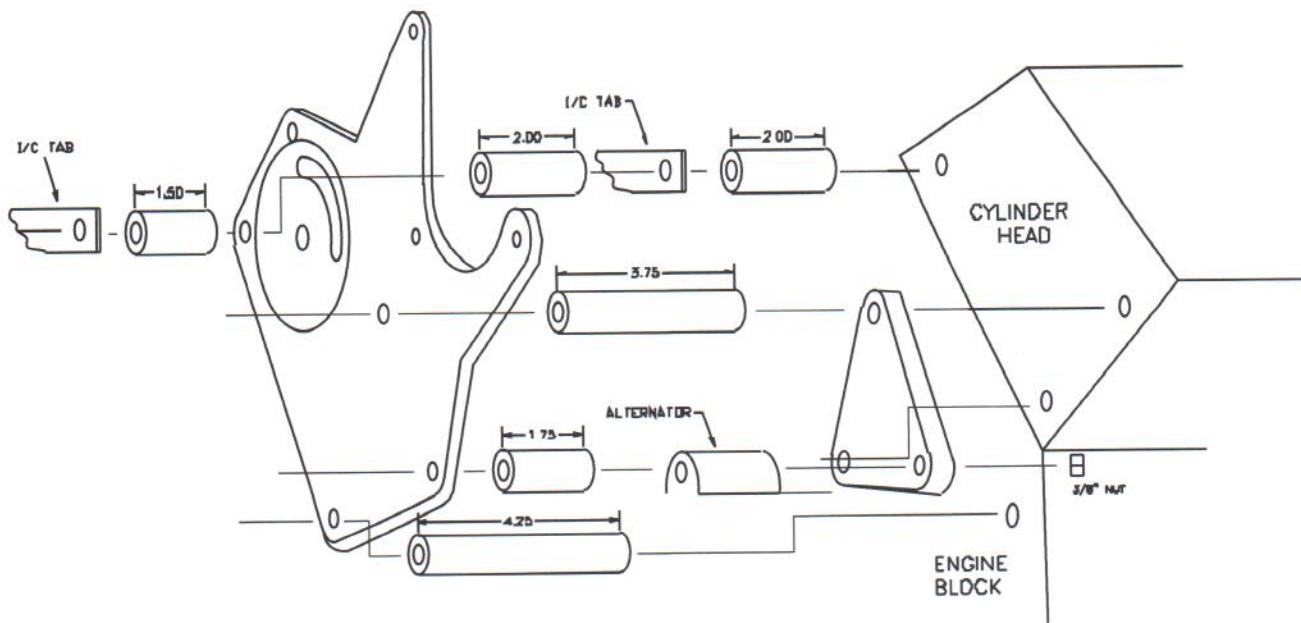

FIGURE D5
EXPLODED VIEW OF MAIN BRACKET AND SPACERS

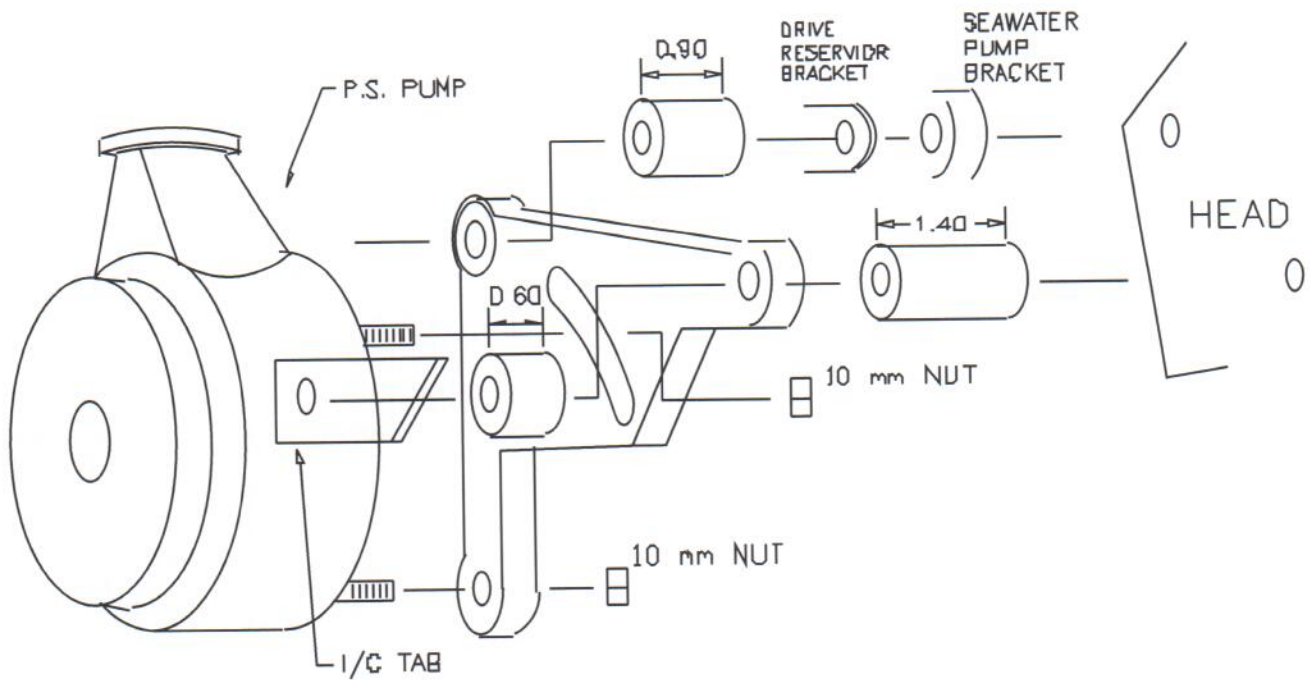

FIGURE D6
EXPLODED VIEW OF POWER STEERING BRACKET AND SPACERS

4. Reattach the factory alternator lower support bracket in its original position. Slide the alternator up so that the upper support hole is in front of hole D3 on the ATI alternator bracket and behind hole A4 on the supplied main bracket. Slide the 1.75" spacer between the alternator and the main bracket. Run the 3/8" x 6" (3/8" x 5.5" on SC system) bolt through the main bracket, spacer, alternator, and alternator bracket and thread the 3/8" nylon locking nut onto back side (see figures D4 and D9). Leave somewhat loose until you tighten alternator belt.
5. Attach the pistol shaped power steering bracket to the starboard side head oriented as shown in figure D3. The countersunk hole (C1) aligns with the outboard-most hole in the seawater pump bracket where the stud was removed in step 1, with the .90" spacer placed between the power steering bracket and the seawater pump bracket. Use .150" spacer instead of .90" if seawater pump bracket not present. Hole C2 should line up with the inboard-most starboard head bolt hole.
6. If you will be mounting your intercooler remotely, follow 6R and 7R, otherwise, proceed with 6 and 7. Take the intercooler (I/C). The I/C tabs should be on the bottom of the I/C with the side with two tabs facing the port side of the motor. Attach the starboard side tab to the power steering bracket and the starboard side head in the following sequence: I/C tab in front, then the .6" spacer, then hole C2 in the power steering bracket, then 1.40" spacer against the head. Run the 7/16" x 3.25" bolt through all four, and thread into the innermost head bolt hole. Leave slightly loose so that you can rotate the I/C into place on the port side. (see figures D5 and D7)
- 6R. Use the other power steering spacer (1.4") and 7/16" x 2.5" bolt to bolt C2 to the head.
7. The port side I/C tabs will mount to the innermost bolt hole on the port side head in the following sequence: front I/C tab in front, then 1.5" (1.8" on SC systems) spacer, main bracket hole A1, then 2" spacer, then rear I/C tab, and finally the other 2" spacer. Run the 7/16" x 7" bolt through, and thread into the head bolt hole. (see figures D6 and D8)
- 7R. Using the other 4.25" spacer and 7/16" x 5.5" (7/16" x 5" on SC system) bolt, bolt hole A1 to the head.
8. Securely tighten all bolts installed up to this point .

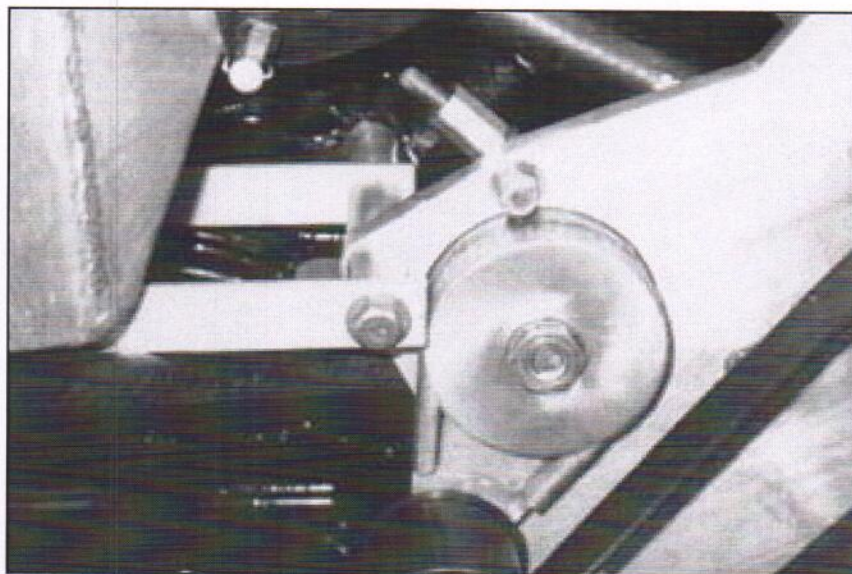

FIGURE D7
PORT SIDE INTERCOOLER TABS MOUNTED
TO MAIN BRACKET AND HEAD.

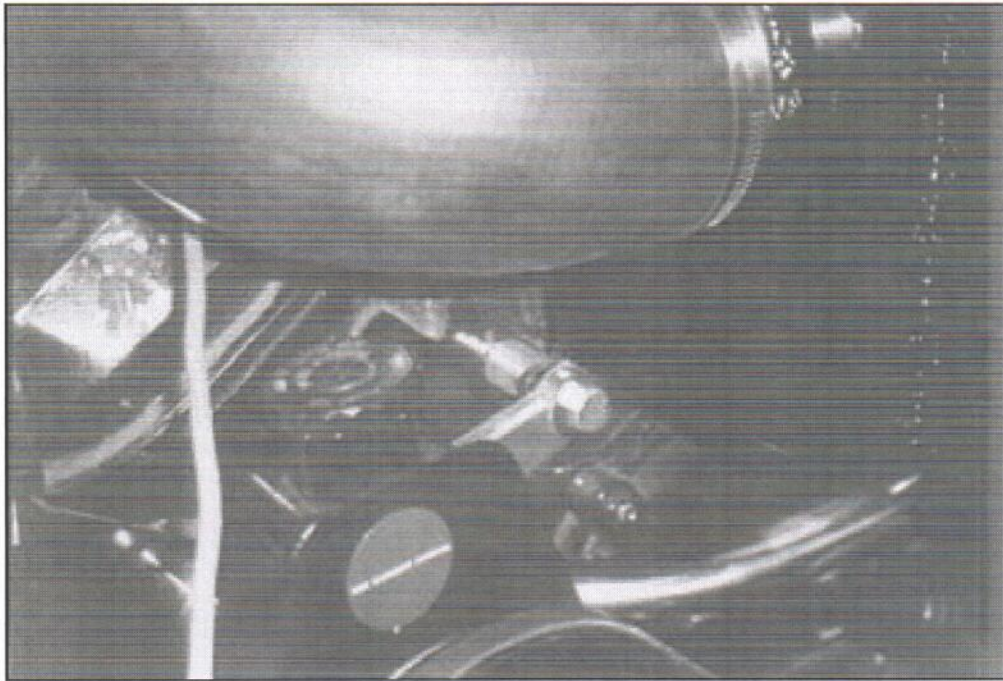

FIGURE D8
**STARBOARD SIDE INTERCOOLER TABS MOUNTED TO THE
POWER STEERING BRACKET AND HEAD.**

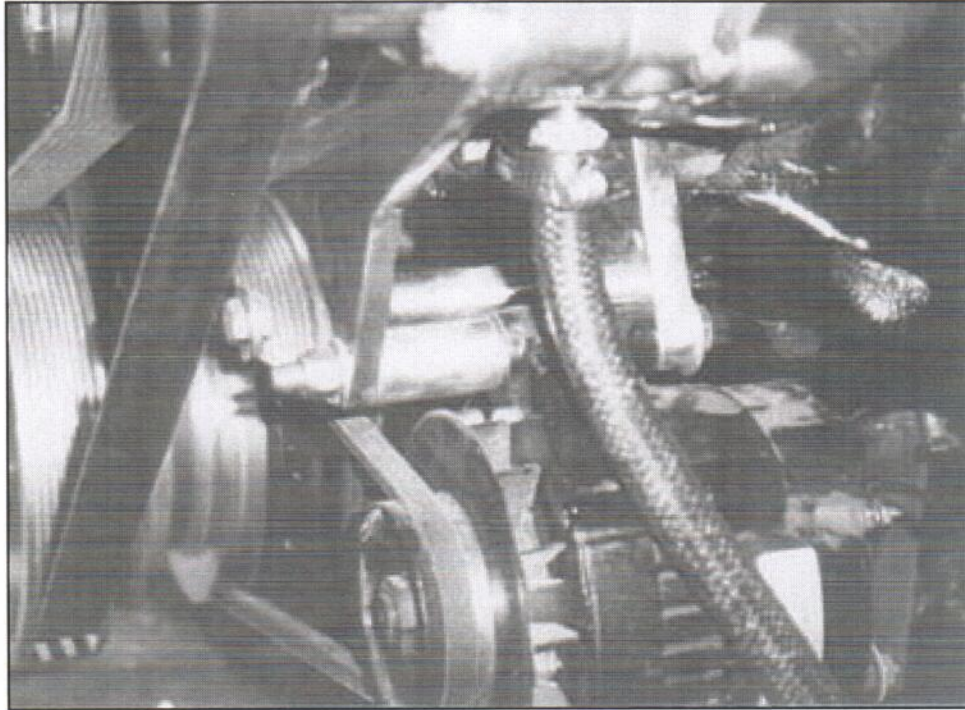

Figure D9
**THE COMBINATION OF BRACKETS, SPACER, AND ALTERNATOR ALL BOLTED TOGETHER.
ALSO NOTE THAT, THE OIL RETURN LINE SHOULD DRAIN CONTINUOUSLY DOWNHILL FROM
THE ProCHARGER, WITH NO KINKS IN THE LINE.**

9. Remove the factory angled support bracket from the front of the power steering pump. Reverse the ends of the bracket so that the shorter end is now at the pump. Reattach to the pump.
10. Two bolts hold the seawater pump idler pulley to the seawater pump bracket. Remove the upper of the two bolts.
11. Place two thinnest shims (previously removed from the upper stud) over the lower power steering stud. Install the power steering pump with the lower stud through hole C3 in the power steering bracket. The upper stud goes into the arched groove. The lower support bracket bolts to the seawater pump bracket at the point where the bolt was removed in the previous step. Thread the original nuts down onto the studs.
12. The power steering lines will need to be rerouted to reach the pump. The high pressure fitting should be brought up from underneath the pump (instead of from above as before). Before securing line to pump, ensure there is proper clearance for the line while tensioning the power steering belt. Secure line. The return line should be replaced by the supplied section of 3/8" line, cut to proper length, and clamped onto its fitting. The pulley on the power steering pump may need to be pushed back on its shaft as much as 1/8" to properly align with the crank pulley. Install the Gates #7390 belt on the alternator, the stock belt on the seawater pump, and the Gates #7417 belt on the power steering pump.
- 13a. M1: Using the supplied 5/16" x 1 1/4" bolts, and holes B1, B2, and B3 on the main bracket, attach the ProCharger to the main bracket. Connect the oil feed line to the fitting on the side of the ProCharger. Attach the oil drain line to the fitting on the pan. Clamp down. Route the oil drain line up to the ProCharger oil return fitting on the bottom of the ProCharger. Cut the line to the proper length and clamp to the oil drain fitting.

This is a gravity feed system; the oil return line must be kink free and downhill the entire length, and should drain into the pan above the oil level line.
- 13b. SC: Using the supplied (4) 5/16" and (2) 3/8" socket head cap screws, attach the ProCharger to the main bracket.
14. Place the serpentine belt around the crankshaft pulley and ProCharger driven pulley. The spring loaded idler should be above the belt pushing down. Turn the 3/8" adjuster nut clockwise to force the idler down onto the belt. Tension to 1/4-1/2 way between the first and second notches on the side of the tensioner. Do not attempt to adjust beyond 1/2 past the first notch on the tensioner; adjusting beyond this point can cause damage or failure of drive system components. Tighten the 1/2" main bolt holding the tensioner to the main bracket, the 3/8" bolt going into the back of the tensioner, and the swing bolt locknut on the front of the bracket.

E. AIR INLET AND INTERCOOLER TUBING INSTALLATION

The intercooler will either be mounted on the engine using the power steering and main bracket spacers, or remotely. If you are using the engine mounted intercooler, it should already have been installed in section D. If you are mounting the intercooler remotely, you will need to do so now with this section as a guide.

Description and Operation

The intercooler system main components consist of the intercooler and tubing. The intercooler is a two core, plate style, air-to-water heat exchanger. The charge air (compressed and therefore heated) coming from the ProCharger enters the intercooler plenum, passes thru a series of passages and exits the opposite plenum. Water taken from the seawater pump flows through the crossflow

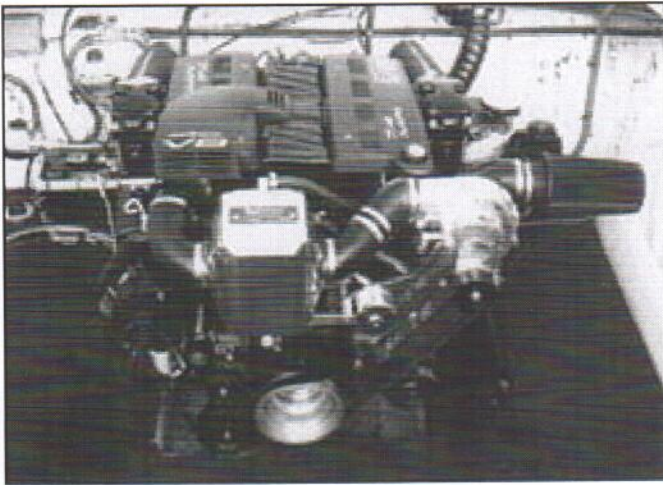

FIGURE E1
TYPICAL ENGINE MOUNT INTERCOOLER

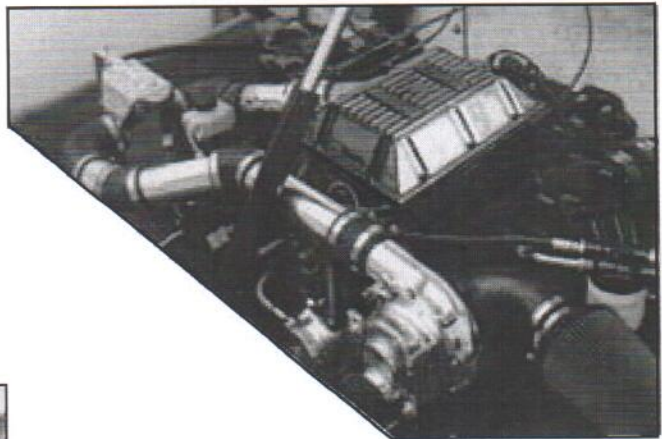

FIGURE E2
TYPICAL REMOTE MOUNT INTERCOOLER

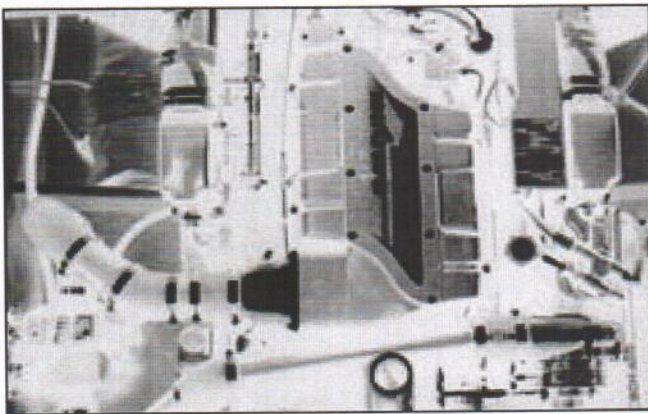

FIGURE E3
TYPICAL REMOTE MOUNT INTERCOOLER



FIGURE E4
TYPICAL REMOTE MOUNT INTERCOOLER

passages in the intercooler, thereby cooling the charge air. The cooled charge air is then routed to the throttle body where it enters the intake manifold. The air inlet system uses a 9" K&N™ air filter to filter intake air.

Engine mounted intercoolers:

1. Review figure E1 before starting. Place supplied 4" inlet elbow over ProCharger inlet. Position the elbow so that it points upward and/or outward to avoid the exhaust manifold and, if applicable, deck above when the filter is installed. If necessary, this elbow can be trimmed to obtain the proper clearance. Temporarily secure with a clamp. On the inlet elbow, position and mark the location of the breather fittings (the plastic 1/2" straight and 3/8" 90 deg fittings). The fittings should be positioned so that the straight 1/2" fitting routes to the port side breather and the 3/8" 90 degree fitting routes to the starboard side breather. Remove the elbow and drill a hole for the 1/2" fitting using a 7/16" drill bit and for the 3/8" fitting using a 5/16" drill bit. Insert the fittings and re-install the inlet elbow.
 - 1a. Using the supplied 1/2" X 2 ft and 3/8" X 2 ft hose, route the valve cover breather fittings to the inlet elbow fittings, cutting the hose to length as required.
 - 1b. Insert the 4" end of aluminum reducer into the inlet elbow and secure with a clamp. Attach the supplied K&N air filter to the 3.5" end of the reducer and secure with a clamp.
2. Place supplied S-shaped molded hose over the outlet of the ProCharger and attach to the inlet of the intercooler. Clamp all connections securely.
3. Place one end of a 3" rubber connector over the outlet of the intercooler and clamp.
4. Remove the stock air filter from the throttle body. Remove the four studs which hold the filter and throttle body to the manifold. Using the supplied 5/16" x 4 1/2" bolts, bolt the supplied ATI throttle body flange and gasket, together with the throttle body, to the manifold.
5. Place one end of the other 3" rubber connector over the end of the throttle body flange and secure with clamp.
6. Align and insert the "U" shaped metal tube into the rubber connectors. (the shorter end of the tube, the end that is offset, connects to the throttle body flange). Secure with clamps.

Remote mounted intercoolers:

1. Review figures E2-E4 before starting. Place supplied 4" inlet elbow over ProCharger inlet. Position the elbow so that it points upward and/or outward to avoid the exhaust manifold and, if applicable, deck above when the filter is installed. If necessary, this elbow can be trimmed to obtain the proper clearance. Temporarily secure with a clamp. On the inlet elbow, position and mark the location of the breather fittings (the plastic 1/2" straight and 3/8" 90 deg fittings). The fittings should be positioned so that the straight 1/2" fitting routes to the port side breather and the 3/8" 90 degree fitting routes to the starboard side breather. Remove the elbow and drill a hole for the 1/2" fitting using a 7/16" drill bit and for the 3/8" fitting using a 5/16" drill bit. Insert the fittings and re-install the inlet elbow.
 - 1a. Using the supplied 1/2" X 2 ft and 3/8" X 2 ft hose, route the valve cover breather fittings to the inlet elbow fittings, cutting the hose to length as required.
 - 1b. Insert the 4" end of aluminum reducer into the inlet elbow and secure with a clamp. Attach the supplied K&N air filter to the 3.5" end of the reducer and secure with a clamp.
2. Determine where you are going to mount the intercooler. The intercooler has several mounting tabs attached to it. Find a place where these tabs can be used, it will be out of the way of the engine, and sits close to the level of the outlet of the ProCharger. Generally, you would like to keep it somewhat close to the engine to minimize the distance the charge air has to flow and the

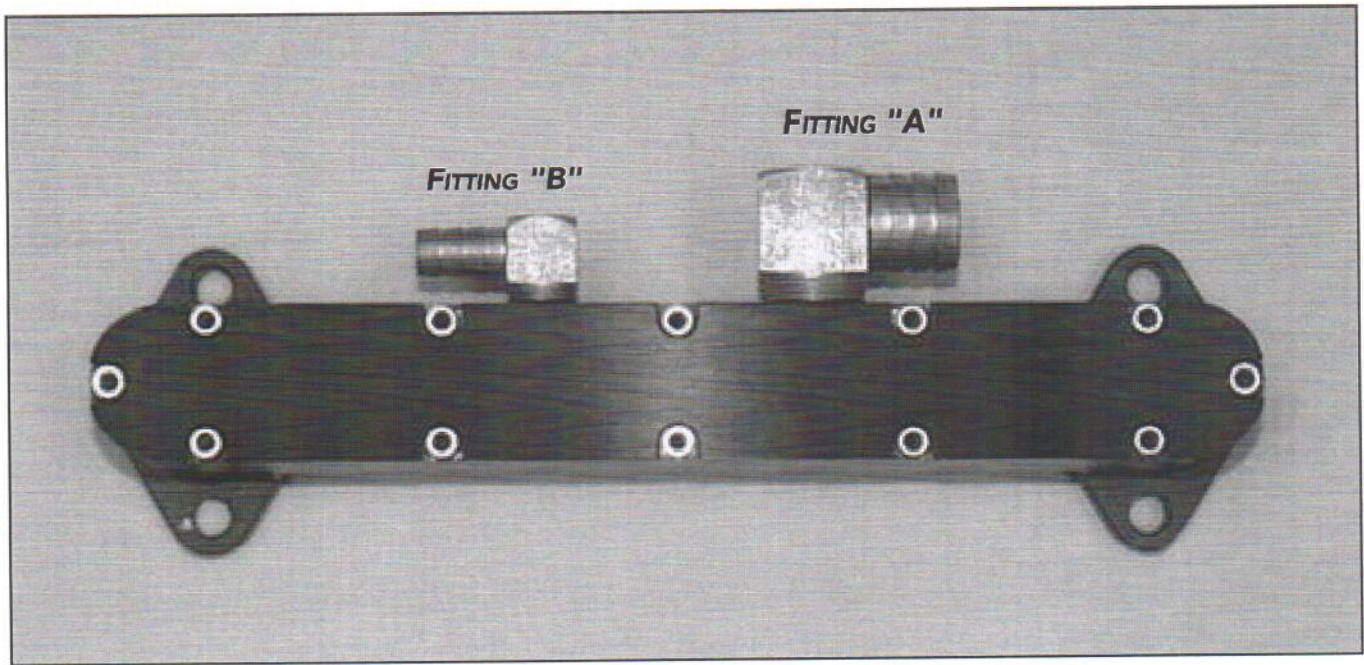

FIGURE F1
CROSSOVER TUBE/WATER TEE FITTING

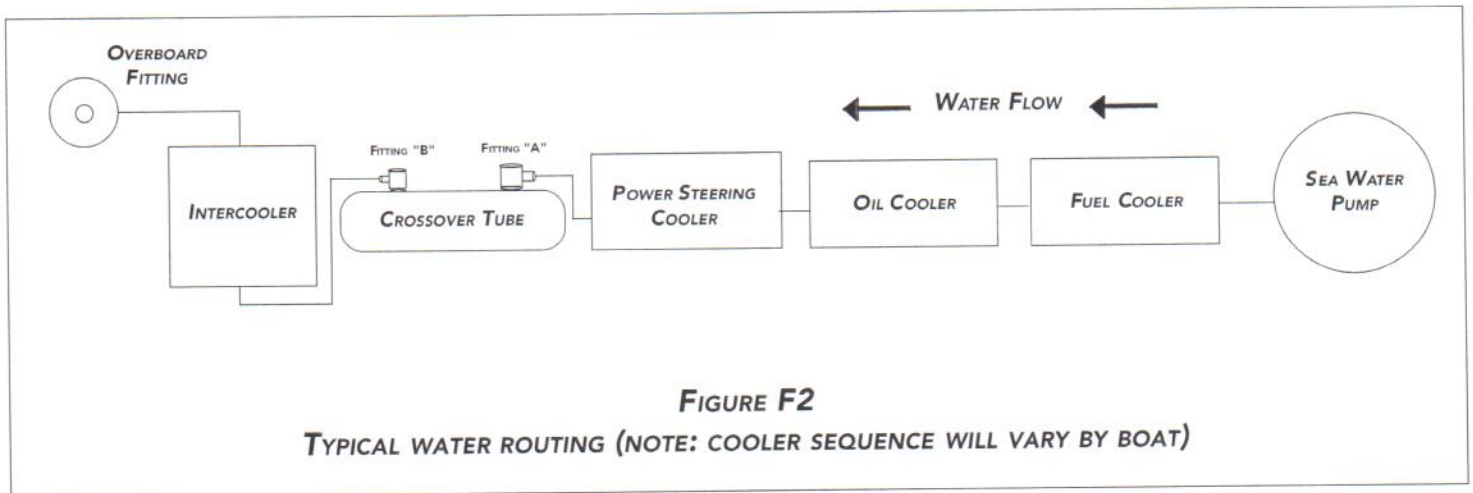

FIGURE F2
TYPICAL WATER ROUTING (NOTE: COOLER SEQUENCE WILL VARY BY BOAT)

number of bends it has to make. Refer to figure E2 for an example. After you have determined the mounting location, bolt or screw the side tabs to the mounting surface. Included in the kit is a straight piece of strap. At the bottom of the intercooler is another tab. Bend and drill the strap so that it can be bolted to the bottom tab and to another mounting surface.

3. Your kit contains a section of 3" O.D. aluminum tubing. You will need to cut this tubing as required to make up your tubing system. After you make a cut, clean up the ends with a file or sander and flare. Flare the end by closing down a crescent wrench so that it just fits over the tubing wall. Pull out on the wrench slightly so that about 1/4" of the wall is crimped outward at about a 20° angle. Do this all the way around the tube. When done, fit a rubber connector over the end to make sure it is not flared too much. After the first one, you should get a good idea of how much flare is needed.
4. Measuring out the proper distances, use a series of straight metal tubes, rubber connectors, and rubber elbows, to run between the outlet of the ProCharger and one side of the intercooler, being sure to bend around obstructions.
5. Remove the air filter from the throttle body. Remove the four studs which hold the filter and throttle body to the manifold. Using the supplied 5/16" x 4.5" bolts, bolt the ATI throttle body flange, together with the throttle body, to the manifold.
6. Again, using a series of metal tubes, connectors, and elbows, plumb the intercooler tubing from the other side of the intercooler to the 3" end of the throttle body flange being careful to bend away from obstructions and moving parts. Clamp all connections on the system securely with the supplied hose clamps.
7. Test your intercooler system to ensure that it is rigidly mounted (it will be full of water when in operation) and does not interfere with other systems within the engine compartment.

F. WATER LINE INSTALLATION

DESCRIPTION AND OPERATION

The water lines established in this section allow water to be routed to and from the air-to-water intercooler. This is accomplished by routing hose to crossover tube fitting for the feed line, and installing an over board fitting for the discharge line.

1. Reattach the 1" water lines running to the exhaust to the fittings on the thermostat housing.
2. Attach supplied 1/2" hose to small barb fitting on crossover tube. Route hose away from belts and attach to lower fitting on intercooler. It is important that the water feed line for the intercooler be attached at the bottom and the discharge at the top, otherwise the intercooler will not fill up with water and will provide little cooling effect.
3. Intercooler over board fitting can be located in either two locations above the drive unit for cooling (if not using drive shower) or on driver side of hull for water flow verification through intercooler. Drill a hole to match the size of the outer diameter of the supplied overboard. Cover the outside of the fitting with silicone and slide through the hole with the barb fitting on the inside. Tighten down the nut on the fitting to secure the fitting to the hull. Attach remaining 1/2" hose to top fitting on the intercooler route hose to over board fitting and clamp securely at both ends.

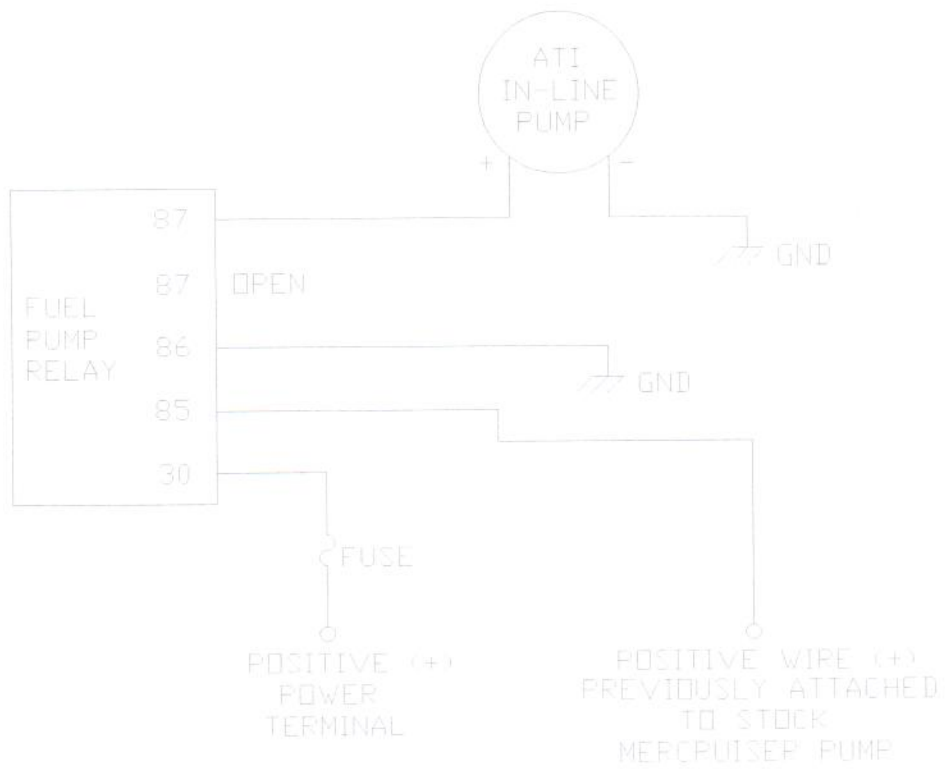

FIGURE G2
FUEL PUMP RELAY WIRING DIAGRAM
'96 AND OLDER

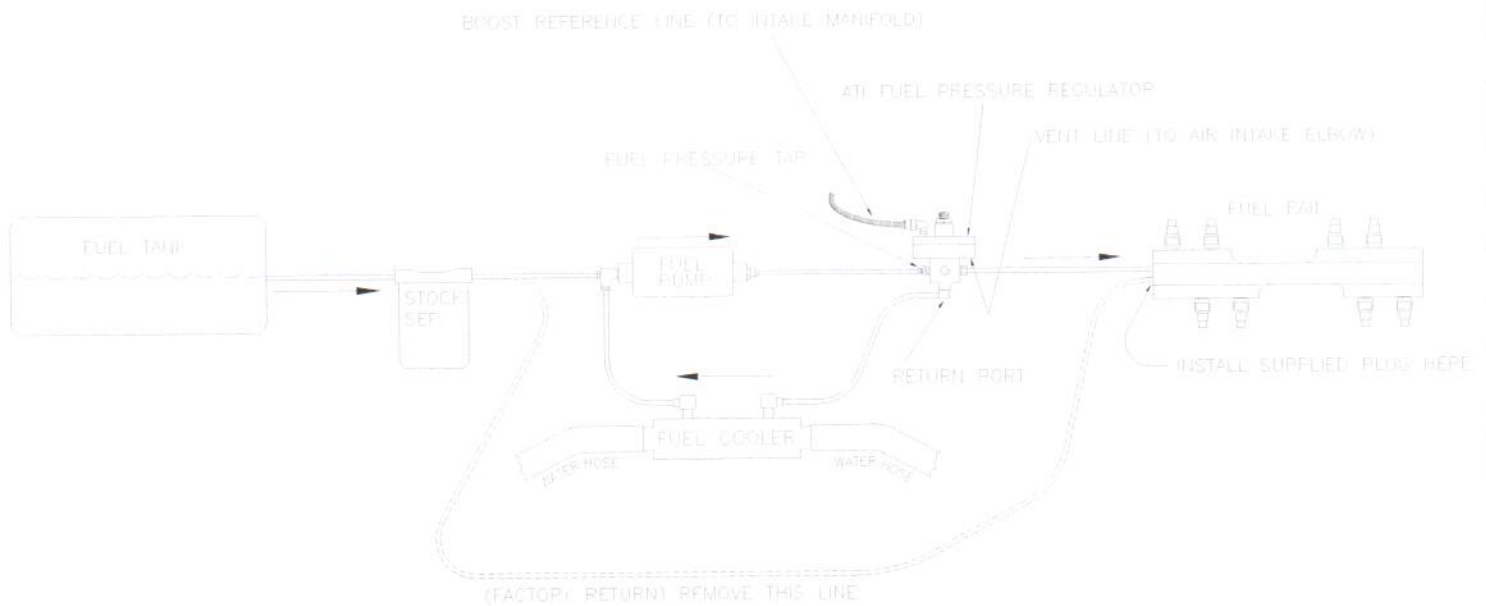

FIGURE G3
EFI FUEL SYSTEM SCHEMATIC
PRE '97 EFI SYSTEMS

G. FUEL SYSTEM INSTALLATION



Warning/Caution: This is a high pressure EFI fuel system. When working on the fuel system, there will be a small amount of high pressure fuel discharged when initially opening up the system. Proper precautions should be taken to contain or minimize spillage (i.e. catching fuel in a container or soaking up fuel in a rag) and avoid exposure to spark or flame (i.e. disconnect battery, no smoking, etc.).

DESCRIPTION AND OPERATION - (ALL)

The fuel system consists of a high flow, high pressure fuel pump and a fuel regulator. The fuel pump is installed between the water separator and fuel rail and replaces the stock pump. Fuel pressures in excess of 60 psi can be attained with your stock injectors. The fuel pump is wired into your stock fuel pump harness and operates only when the stock pump would operate. Since the internal drive motor is a dc type motor, the pump output is dependent on proper voltage (13.5 vdc) and requires correct orientation of the positive and negative power leads (as specified near the power terminals of the pump) in order to flow in the correct direction. The fuel regulator is a air-over-spring type regulator. It uses a spring pressure against vacuum to control idle fuel pressure; and boost pressure to increase fuel pressure when positive manifold pressure is sensed. Because this increased fuel pressure is not sensed by the computer, the injectors are cycled on a normal acceleration schedule. Since the fuel pressure under boost is now higher than the stock fuel pressure, the engine receives more fuel for each injector pulse, and the proper air/fuel ratio is achieved. The ATI regulator controls fuel pressure under all engine conditions, therefore the stock regulator is not needed (and is bypassed).

1996 and older fuel systems



Warning/Caution: Ensure that all fuel lines are correctly sized for the supercharged horsepower rating of the engine. Please contact an ATI service technician should you have any questions.

1. Find a location near the water separator to mount the fuel pump assembly. Mount as low as possible in the boat, preferably on the stringer. Position the pump so that the outlet of the pump faces the back of the motor. Attach the pump assembly using supplied screws. See figure G3 for fuel system layout.
2. Remove the fuel lines running to the stock mechanical fuel pump. Remove the fuel pump from the seawater pump. Install the supplied block-off plate in place of the stock pump.
3. Remove the steel line from the water separator. Only the line from the fuel tank should still be connected to the water separator. Using the supplied fitting, run a line from the outlet of the water separator to the inlet of the supplied ATI fuel pump assembly.
- 3a. Locate the fuel line attachment point at the back of the fuel rail near the distributor. There is a single bolt holding a retaining clip for the (2) fuel lines. Remove this bolt and retaining clip. Note: It may be necessary to remove the distributor cap to get access to this bolt. Remove the return line (the lower of the two lines) and install supplied brass plug and o-ring. Re-install retaining clip and bolt (and distributor cap, if removed).
4. On the rear of the computer box (just to the port side of the stock electric fuel pump and VST (vapor separator tank)) are two bolt holes, one above the other. Mount the ATI regulator/bracket assembly to these holes using two supplied 1/4" x 3/4" bolts and lock washers. The regulator should be mounted so the adjuster screw is on top. See figure G6.
5. Disconnect the outlet fuel line from the stock electric fuel pump (located just aft of the VST tank). (This is the only line still attached to the fuel rail) Attach the line to the inverted flare fitting on the ATI regulator.
6. Disconnect the return line at the VST (the return line is marked "RETURN" and has an inward arrow) and discard.

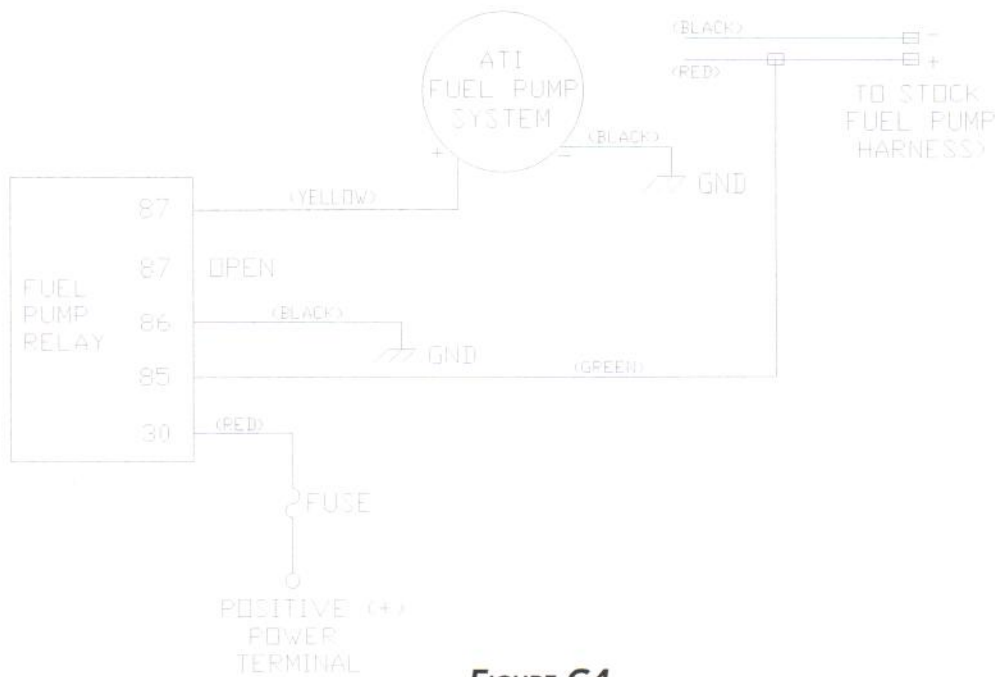

FIGURE G4
FUEL PUMP RELAY WIRING DIAGRAM
('97 AND NEWER)

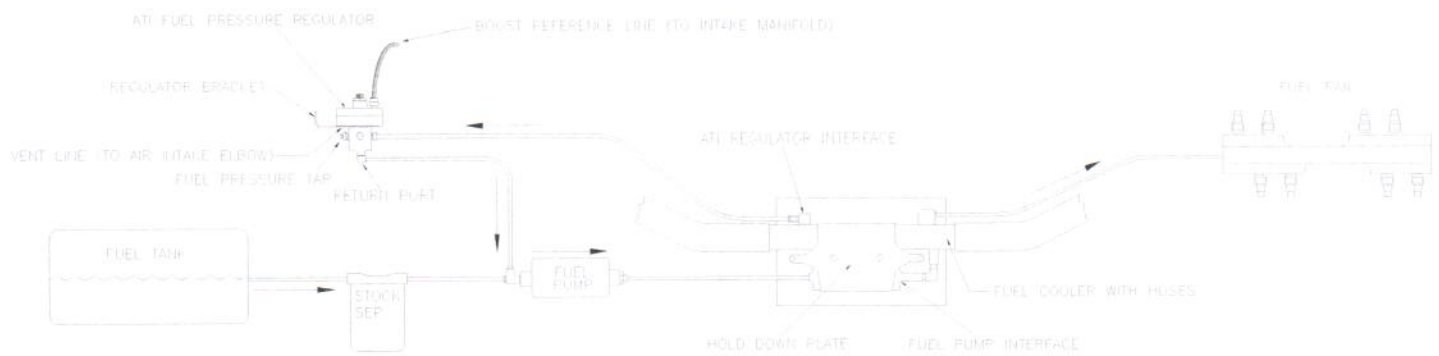

FIGURE G5
FUEL PUMP SCHEMATIC
'97 AND NEWER EFI "COOLFUEL" SYSTEMS

- 6a. Using supplied 3/8" fuel hose, route a line from the outlet of the ATI fuel pump to the barb fitting adjacent to the fuel rail hose on the ATI regulator and secure with hose clamps.
7. Install supplied fuel cooler in the 1 1/2" water line directly after seawater pump. Note: the cooler can be mounted in either direction. See figure F2.
8. Run the line connected to the fuel inlet on the fuel cooler (the downstream port on the side of the cooler) to the bottom fitting on the regulator (marked "ret"). Connect the line from the fuel outlet on the cooler to the vacant port on the tee at the ATI fuel pump inlet.
9. Route the vacuum (boost reference) line from the top of the regulator to the fitting on the intake manifold previously used by the stock regulator and secure with clamps.



Warning: Do not use the vacuum fitting on the back of the intake manifold for the boost reference vacuum source. This fitting has a small orifice and will not supply a strong enough vacuum/boost signal.

Route the vent line (located on the underside of the top half of the regulator) from the ATI regulator over near the supercharger inlet. Drill or punch a 3/32" hole in the inlet elbow (between the supercharger and air filter) and insert exposed end of brass barbed fitting installed in end of vent line. Although the regulator is preset at the factory, fuel pressure must be checked upon completion of installation; if necessary the regulator should be adjusted to either increase or decrease fuel pressure (See section H.).

10. Attach the fuel pump relay and wiring harness to the hole in the regulator bracket with a 10-24 bolt, nut and washers. Review Figure G2.
11. Attach the yellow wire from the relay (#87) to the positive(+) terminal of the ATI pump.
12. Attach the black ground wire from the relay (#86) to the ground (-) terminal of the ATI pump.
13. Remove both electrical wires from the top of the stock electrical pump. Connect the green wire from the relay (#85) to the positive wire previously attached to the stock pump, just forward of the fuel feed fitting.
14. Attach the loose black ground wire between the ground on the ATI fuel pump and a ground terminal on the ground terminal strip. If no strip is present, attach to the ground on the lower starboard side on the rear of the engine block.
15. Run the red wire from the relay (#30) to the power terminal on the alternator or on the battery terminal utilizing the supplied inline fuse and ring connector.
16. Remove the steel line connected to the inlet of the stock fuel reservoir. Discard the line. Remove the line running between the reservoir and the intake manifold marked "VENT". Block off the port on the manifold with a vacuum cap and secure with wire tie. There should now be no lines running to or from the stock fuel pump/reservoir. Remove stock fuel system from intake and store with hardware already removed from motor. Caution: fuel system/VST is still full of gasoline!
17. After complete installation of supercharger system, the fuel pump should be operated (hot-wired) to check for leaks. Additionally, although the regulator is preset at the factory, fuel pressure will need to be checked and monitored during initial start-up and testing

DESCRIPTION AND OPERATION - 1997 AND NEWER FUEL SYSTEMS

The '97 Mercruiser fuel system has a single electric fuel pump which draws fuel from the tank through the separator, and pumps it through a fuel cooler to the fuel rail. Returned fuel from the fuel pressure regulator is circulated back to the separator. ATI supplies a high output replacement fuel pump, a fuel pump interface (which replaces the stock fuel pump), a fuel pressure regulator

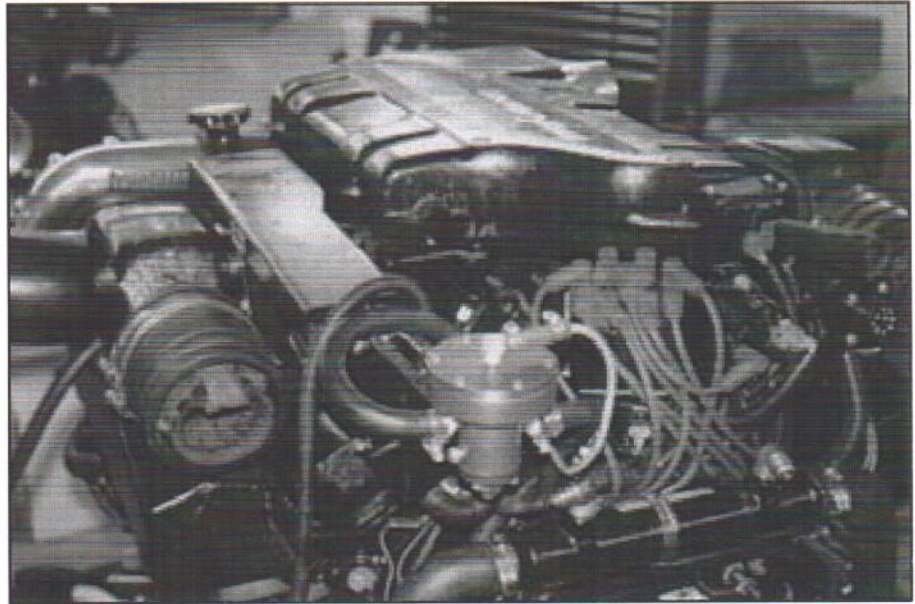

FIGURE G6
FUEL PRESSURE REGULATOR

REPLACE STOCK REGULATOR WITH
REGULATOR INTERFACE

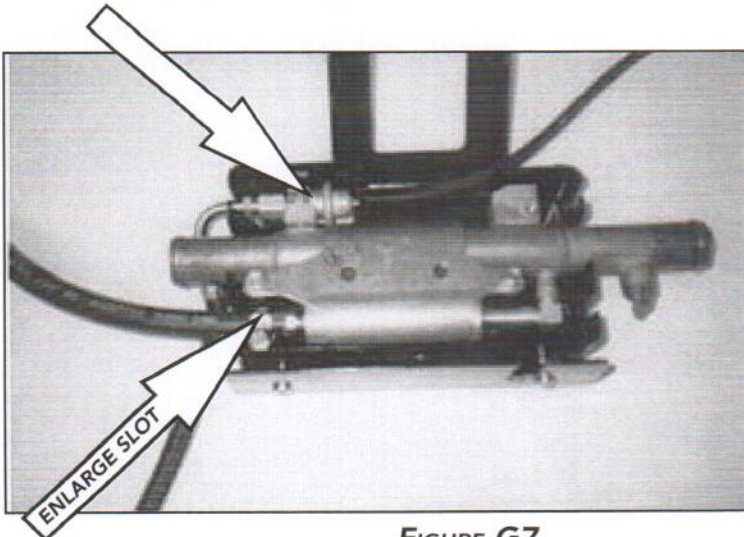

FIGURE G7
SUPPLIED FUEL SYSTEM INTERFACE REPLACES STOCK FUEL PUMP

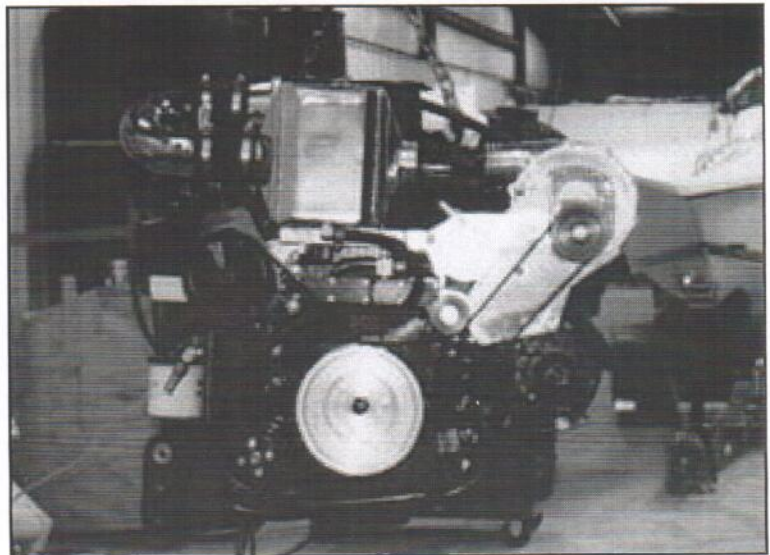

FIGURE H1
COMPLETED PROCHARGER SYSTEM INSTALLATION

interface (which replaces the stock regulator) and a boost sensitive fuel pressure regulator. This pump needs to be mounted as low as possible so that it is gravity fed, as it is a roller vane style pump (these types of pumps do not create high suction forces, but are capable of producing high output pressure and flow). The boost sensitive regulator controls the fuel pressure under all manifold conditions (both vacuum and boost), providing the extra fuel needed under boost conditions.



Warning/Caution: Ensure that all fuel lines are correctly sized for the supercharged horsepower rating of the engine. Please contact an ATI service technician should you have any questions.

1. Locate the stock fuel pump enclosure adjacent to the port side engine mount. Detach the assembly from the motor. Remove the plastic cover and the metal bracket retaining the pump and fuel cooler. Remove the wiring harness from the pump. Review Figure G7.
2. Remove the fuel cooler and stock pump from the box.
3. Disconnect the fuel return line and vacuum line from the stock regulator on the fuel cooler. Remove the stock regulator and screen under the stock regulator. Discard screen. Replace with the supplied regulator interface and o-ring. Reattach fuel line to regulator interface.
4. Disconnect the fuel line running between the stock fuel pump and the water separator at the separator. Remove the fitting from the separator. Install the supplied 1/4" NPT - 3/8" barb fitting into the separator in its place. Refer to Figure G5 for fuel system schematic.
5. Find a convenient location for the supplied fuel pump to be mounted along the stringer. The pump should be located as low in the boat as possible. Using the provided brackets, install the fuel pump securely with bolts or lag screws.
6. Attach the inlet hose from the supplied fuel pump to the barb fitting installed on the water separator and secure with hose clamp. Route the fuel pump outlet hose over to the near the fuel cooler assembly.
7. With a round file, enlarge the slot in end of fuel box and the cover to allow for the supplied 3/8" fuel line. Install supplied fuel system interface and fuel cooler into box (see figure G7). Connect the fuel outlet line from the fuel pump to the barb fitting on the interface and secure with hose clamp. Re-install retaining bracket and plastic cover. Re-attach the assembly to the motor.
8. On the rear of the computer box are two bolt holes, one above the other. Mount the ATI regulator/bracket assembly to these holes using two supplied 1/4" x 3/4" bolts and lock washers. The regulator should be positioned so that the adjustment screw is on top. See figure G4.
9. Locate the line on the separator that runs to the regulator interface on the fuel cooler. Unscrew the line from the fitting on the separator. Attach the line to the inlet of the ATI regulator. (the port with the female inverted flare fitting installed) Remove the fitting from the separator and replace with 1/4" NPT plug.
10. Attach the return line from the ATI regulator (the bottom port marked "ret") to the "T" fitting installed at the inlet of the fuel pump. See figure G5.
11. Route the boost reference line from the top of the regulator to the PCV orifice above the thermostat housing. Be sure to lightly pull both ends of the boost reference line to seat the o-ring in the fitting.







Warning: Do not use the vacuum fitting on the back of the intake manifold for the boost reference vacuum source. This fitting has a small orifice and will not supply a strong enough vacuum/boost signal.

Route the regulator vent line (the 1/8" barb fitting pointing downward from the regulator) over near the supercharger inlet. Punch or drill a 3/32" hole in the air inlet elbow (between the supercharger and air filter) and insert exposed end of brass barbed fitting installed in end of vent line.

12. Attach the black ground wire from the relay (#86) to a ground on the engine or to the negative ground terminal on the fuel pump.
13. Attach the yellow wire from the relay (#87) to the positive terminal on the fuel pump.
14. Attach the short black wire from the negative ground terminal on the fuel pump to a ground on the engine or in the boat.
15. Connect the green wire from the relay (#85) to the red wire in the stock fuel pump wiring harness.
16. Run the red wire from the relay (#30) to the power terminal on the alternator or on the battery terminal utilizing the supplied in-line fuse and ring connector.
17. Test your connections by turning the key to the "ON" position. You should hear the fuel pump start. Before operating the boat, start the engine and check for fuel leaks and proper fuel pressure. See section H regarding fuel pressure requirements.

If you require technical support, please contact us at (913) 338-3086 9:00-5:00 CST, Monday - Friday, or contact technical services via email at techserv@procharger.com

H. INSTALLATION REVIEW AND SAFETY CHECK

1. Carefully review the entire installation (figure H1). Check oil and fuel lines near moving parts and the exhaust system to ensure that these lines are safe, secure and not twisted or kinked. All wires and hoses should be firmly secured with clamps or wire ties. Also, ensure that the inlet screen is installed on the back of the ProCharger.
2. Check all fluid levels. Your tank should be filled with **91 octane** or higher fuel before hard running. **For SC ProCharger models, you must add oil to the supercharger before operation.**
3. Start engine and idle for a few minutes. You should be running stock Mercruiser timing. Check and adjust if necessary.
4. Shut off engine and check for fluid leakage, signs of rubbing parts, and other potential problems
5. Your motor should display a significant increase in performance when you are hard into the throttle, with no detonation. If this is not so, review your installation, then contact your dealer or ATI for assistance. Mercruiser EFI engines are designed to run slightly rich for maximum reliability.
-  6. For best performance and reliability, **always use premium grade fuel (91 octane or higher)** and listen for signs of detonation. Back off throttle should detonation occur. With a properly installed ProCharger and appropriate timing, detonation should not be an issue.
7. Never race your engine (and ProCharger) when the engine is cold. Allow water temperature to climb into operating range before revving above 2,500 rpm.
8. Be sure you have purchased and properly installed a fuel pressure gauge and/or fuel/air ratio meter to monitor fuel delivery. Installation of a boost pressure gauge is also recommended. The fuel pressure gauge should be plumbed into the ATI fuel pressure regulator (one of the ports is already reduced down to 1/8" fpt for installation of a fuel pressure gauge). A boost gauge can be plumbed (tee'd) into any port on the intake manifold.
-  9. **After the system is installed, fuel pressure at idle should be checked.** The idle fuel pressure should be 30-34 psi. Under full boost conditions (5-6 psi) fuel pressure should increase to 48-54 psi. Fuel pressure can be adjusted by tuning the regulator. Regulator tuning is accomplished by loosening the jam nut on the regulator with a 3/4" open end wrench, and then using a 1/4" allen wrench to adjust fuel pressure. Clockwise raises fuel pressure; counterclockwise reduces pressure. Remember that leaning the fuel pressure will increase HP but can create an extremely dangerous lean condition. **Be careful and ensure that you always maintain adequate fuel pressure!** Contact ATI for special applications requiring regulator modifications for higher rates of gain.
10. Mercruiser EFI/MPI rev limiters cut off fuel to limit rpm, which can cause a dangerous lean condition. Ensure that boat is propped so that maximum rpm is below factory rev limiter. **Repeatedly bumping/riding rev limiter can result in serious engine damage.**
-  11. It is very important that all fuel lines are sized according to the supercharged horsepower rating of the engine. This includes the anti-siphon valve, fuel filters, etc. . Please contact an ATI service technician should you have any questions.
-  12. Review the maintenance and warranty sections within this owner's manual.

TUNING

Fuel Pressure

On a fuel injected motor, adequate fuel pressure is the most important factor in maintaining the correct fuel-air ratio. When supercharging a fuel injected motor, extra fuel beyond that supplied by the Mercruiser computer and fuel system is required, due to the extra oxygen in the cylinder. This extra fuel is provided by increasing the fuel pressure when under boost. It is extremely important to check the pressure as the motor may run seemingly fine, but due to insufficient pressure is running dangerously lean. Fuel pressure can be increased or decreased by adjusting the regulator. See section H for fuel pressure requirements. Additional modifications to the motor may require additional fuel, please contact ATI for additional fuel requirements.

Timing

All motors may require subtly different timing for best tuning. However, as most motors are close to the same, we can give general guidelines. Most medium sized V Hulls, twin engine applications, and generally boats with 1.50 gear ratios or more (lower) that are able to plane with relative ease in a tall propped, high speed setup, will generally not need as much initial timing. Dyno results have shown that most moderate compression GM BB's, such as Mercruiser types will not show significant variances in peak HP if total timing is between 29-32°. However, in the previously mentioned boat types which exhibit good planing & driveability characteristics, backing the timing down from the 32° Merc. Stock setting can provide some additional margin for error in the event the boat is operated with insufficient octane fuel and/or other abuses. Large single engine boats, high speed tunnel cats, and other high performance and/or 1.36 geared boats may benefit from the more advanced Merc. total 32° specification, since this will essentially increase on-plane torque due to non-aggressive low RPM tuning. Although this aggressive timing will not allow as great a margin of error at WOT, this should not pose a problem, due to the fact that these high performance applications are only capable of short bursts of full throttle operation due to water speed and general safety conditions. Obviously, the manner in which the desired timing is set will ultimately influence the FMU setting and fuel pressure.

Plugs

As to reading the plugs, the following information should help identify what to look for: What we want to focus on is the threads. The threads are directly connected to the cylinder, and so when the plug is removed, essentially part of the combustion chamber is removed. On almost all cases the appearance of the top of the plug threads is also what the chamber and pistons look like. We want the threads and the chamber to be black and have soot deposits. This indicates a rich supercharged condition and therefore would mean cooler exhaust temperatures. The negative ground should be clean and show no signs of blue discoloration. The electrode should be clean and white; this indicates good combustion. The following are signs of problems: If the negative ground is discolored, it indicates high temperatures. If the electrode is fuel soaked or black this indicates a misfire or fouled plug condition. If any of the 1st thread is not completely black, there is not enough fuel in the cylinder. Even if only a small part of the thread's circumference is clean, this condition may produce excellent power, but will probably produce excessive cylinder temperatures.

OPERATION AND MAINTENANCE

- **COLD STARTING**

Never race your engine (and ProCharger) when your engine is cold. Allow the water temperature to climb into operating range before revving above 2,500 rpm, to ensure adequate oil lubrication.

- **FUEL QUALITY**

For best performance and reliability, **always use premium grade fuel (91 octane or higher)**. Always listen for signs of detonation after refueling, and after replacement or modification of any fuel system components. Back off throttle should detonation occur. With a properly installed ProCharger intercooled supercharger system, detonation should not be an issue

- **OIL AND FILTER MAINTENANCE**

M1 only: Always change your oil and filter every 25-30 hours. Delaying your oil change beyond the recommended interval risks the health of both your high performance engine and ProCharger. M-1SC and M-3SC models, See SC applications page for SC oil change intervals.

- **IGNITION SYSTEM MAINTENANCE**

If your spark plugs are more than two years old or have more than 100 hours use, you should change your plugs before operating your boat under load. Additionally, spark plug wires should be changed every 200 hours of use, or whenever resistance exceeds factory specifications.

- **AIR INLET**

Your motor and ProCharger should never be run without an air inlet screen!

- **BELT TENSIONING AND REPLACEMENT**

The belt which turns your ProCharger will stretch after initial run-in, and may need retightening after the first few hours, if not sooner. After possibly one more tightening of the belt with the tensioner, further stretching should not occur. Tighten the belt sufficiently to avoid slippage, but do not overtighten, as this could cause damage to the ProCharger's precision bearings. Should you throw a belt and find that it needs constant re-tightening, the belt is damaged and should be replaced. 8-rib belts can be bought from ATI or your local parts store. Gates Micro-V belts are recommended; these belts are available at CarQuest™, NAPA™ and other auto parts stores. Your nearest CarQuest store can be found by dialing 800-492-7278, the nearest NAPA store at 800-538-6272.

- **IMPELLER SPEED**

Maximum impeller speed should not exceed the redline stated for each model in the table below. Maximum impeller speed = crankshaft pulley diameter (D1) divided by supercharger pulley diameter (D2), multiplied by the step-up ratio stated in the table, multiplied by engine rpm at redline.

$$\text{Impeller RPM} = (D1/D2) \times (3.05, 4.10 \text{ or } 4.44) \times \text{engine RPM}$$

Model:	M1B	M1	M1SC	M2	M3SC	M3SCR	M3	M4
RPM (MAX):	54,000	50,000	57,000	59,000	50,000	54,000	57,000	50,000
Step-Up Ratio:	3.05:1	3.05:1	4.10:1	4.44:1	4.10:1	4.10:1	4.44:1	4.44:1

If you require technical support, please contact us at (913) 338-3086 9:00-5:00 CST Monday - Friday, or contact technical services via email at techserv@procharger.com

SC APPLICATIONS

- **WARNING:**



ALL SC SUPERCHARGERS CONTAIN NO OIL FROM THE FACTORY. YOU MUST ADD THE SUPPLIED PROCHARGER OIL PRIOR TO USE.

Use only ATI supplied oil in your SC ProCharger. The ATI oil has been specially formulated for the bearings in the ProCharger and use of oil other than that supplied by ATI will void your warranty.

- **OIL CHANGE INTERVALS**

The first oil change should be performed at 15 hours and at 100 hour intervals thereafter. Clean drain plug after every oil change. Drain oil by removing the magnetic drain plug. Clean off the magnetic drain plug before reinstalling. *See figure below, left*

- **OIL LEVEL**

The oil level must be checked periodically (when cold) to ensure the proper oil level in the ProCharger. The dipstick can be loosened using a flat blade screwdriver or a coin. When installed, the oil level should be between the min and max levels (See fig. below). If the oil level falls below min, fill the ProCharger, through the dipstick hole, until the proper oil level is reached. **Warning: Filling the ProCharger higher than the "max" level on the dipstick will lead to bearing and/or seal damage.** The SC ProChargers are sealed units and normally will not require the addition of oil between service intervals. If excessive consumption is noted, the unit should be sent to ATI for inspection/repair. Disassembly of the supercharger will void your warranty.

- **GENERAL**

When removing the dipstick, be sure to retain the nylon washer. A spare washer is provided with each box of SC oil (a box is included with each system). Do not remove or replace either the nylon washer on the dipstick, or the rubber o-ring on the drain plug with anything other than ATI supplied replacements. **Evidence of either case may void factory warranty.** A discoloration of the oil and residue on the drain plug will be noticed during initial oil changes. This is no cause for concern and will eventually diminish. The serial tag on your SC ProCharger must be pointing upwards for proper orientation. Installing the supercharger in another orientation will result in inadequate oiling and supercharger failure. If you have any questions about the maintenance of your SC ProCharger they should be directed to an ATI service technician or dealer.



SEALED PLUG
(SOCKET HEAD)

MAGNETIC
DRAIN PLUG
(HEX HEAD)



SEALED PLUG
(SOCKET HEAD)

DIPSTICK
(FLAT HEAD)

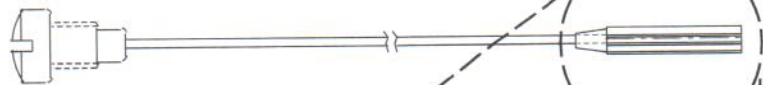

THE PROCHARGER® AND PROCHARGER INSTALLATION SYSTEM LIMITED WARRANTY

Accessible Technologies, Inc. ("ATI") is proud to offer a twelve month limited warranty on its ProCharger supercharger systems and a thirty-six month limited warranty on oil-fed ProChargers (supercharger only) ordered with a 5 psi (or less) pulley. ATI's warranty obligations are limited to the terms set below:

ATI warrants the ProCharger and ProCharger installation system (together "product") against defects in materials and workmanship for a period of TWELVE (12) months from the date of original purchase from your local dealer, or date of shipment from the factory if purchased directly from ATI. If the product is used in its intended manner, ATI will repair or replace any component found to be defective at no charge to the customer. **SHOULD THE CONSUMER ELECT TO USE A DRIVEN PULLEY OTHER THAN THE ORIGINAL PULLEY SHIPPED WITH THE SYSTEM, THIS LIMITED WARRANTY IS VOID.** This warranty coverage is extended only to the original consumer purchaser, and excludes hoses, sleeves and electronic support components manufactured by other companies.

To obtain service under this warranty you must do the following during the warranty period:

1. Phone ATI (913-338-3086) and provide us with the following information:
 - ProCharger serial number
 - vehicle year, make, model, engine modifications and other modifications
 - description of perceived problem
2. If no resolution to your problem can be found after the above phone conversation, you will be assigned a warranty claim number. You must then properly ship your product, at your expense, to the ATI factory. The product should be carefully packaged in a rugged box so that none of the components being shipped could strike each other or the side of the box during shipping. The box should be strong enough to safely contain the weight of the components being shipped.
3. Include the following information inside the box with your product:
 - copy of your original invoice or receipt
 - name, address and daytime telephone number
 - warranty claim number
 - vehicle year, make, model, engine modifications and other modifications
 - description of perceived problem
4. Clearly mark the warranty claim number on the top and one side of the box in characters no less than 2" tall. Ship the properly packaged product, prepaid and insured for the retail value of the component(s) being returned, to the following address:
Accessible Technologies, 14801 West 114th Terrace, Lenexa, Kansas 66215.

ATI agrees to honor a warranty claim at its sole discretion and only after inspection by engineers at the ATI factory. No warranty will be honored if any product subassembly is found to have been improperly installed, tampered with, mishandled or misused in any way. **DISASSEMBLY OF THE PROCHARGER OR REMOVAL OF THE PROCHARGER SERIAL PLATE VOIDS ALL WARRANTIES.** Claims for freight damages should be directed to the freight company.

If ATI's limited warranty applies, your product will be repaired or replaced at ATI's option and shipped back to you, freight prepaid, via 2nd day FEDEX service. If the limited warranty does not apply, we will advise you of the specific reason for denial, and advise you of repair expense and time. After advising you of this information we will, at your option, either proceed with repairs or return your product to you in the state in which it was received. In either case the product will be shipped to you COD, insured at replacement value. This means that you would pay the return shipping and insurance charges if ATI's limited warranty does not apply to your product.

THE WARRANTY AND REMEDIES SET FORTH ABOVE ARE EXCLUSIVE AND IN LIEU OF ALL OTHERS, WHETHER ORAL OR WRITTEN, EXPRESSED OR IMPLIED. THE DURATION OF ANY AND ALL WARRANTIES ON THE PRODUCTS DISCUSSED ARE LIMITED TO TWELVE OR THIRTY-SIX MONTHS AS STATED ABOVE. ATI IS NOT RESPONSIBLE IN ANY EVENT FOR DIRECT, SPECIAL, INCIDENTAL OR CONSEQUENTIAL DAMAGES. No ATI dealer, agent, or employee is authorized to make any modification, extension, or addition to this warranty.

THE PROCHARGER SC EXTENDED COVERAGE PROGRAM

DESCRIPTION

- The ProCharger Extended Coverage Program extends the warranty coverage for your M-1SC or M-3SC ProCharger an additional TWENTY-FOUR (24) months, for a total of thirty-six months. This extended coverage applies to parts and labor for the ProCharger centrifugal supercharger unit only, and does not include other system components.
- Under the extended coverage program, ATI will repair or replace any component within the ProCharger which is found to be defective.
- Service under the extended coverage program is obtained through the same process as described in The ProCharger Twelve Month Limited Warranty.

QUALIFICATION

- Only the original consumer purchaser of the ProCharger is eligible, so long as this purchaser qualifies under the terms described below.
- Completion of the Extended Coverage Registration Form is required, along with a \$49 registration fee. In return for the \$49 registration fee, your system record will be updated to reflect the extended warranty and you will receive (6) additional bottles of ATI SC oil. This form must be completed in its entirety, and must be submitted along with payment within 30 days from the date of original purchase from your local dealer, or date of shipment from the factory if purchased directly from ATI.
- **PARTICIPANTS MUST HAVE ORDERED THE PROCHARGER WITH AN 8 RIB DRIVE SYSTEM WITH THE 5 PSI (OR LESS) PULLEY,** and must agree to maintain this original pulley, and not remove this pulley or disassemble or modify the ProCharger unit in any manner. With respect to the ProCharger itself, all terms and conditions within the ProCharger Twelve-Month Limited Warranty apply. Tampering with the driven pulley and any other modification of the ProCharger unit will disqualify an owner from participating in the Extended Coverage Program. Acts resulting in disqualification include but are not limited to the following:
 - Removal or attempted removal of the ProCharger driven pulley
 - Removal or attempted removal of the ProCharger serial plate
 - Removal or attempted removal of the compressor housing or transmission case
- **PARTICIPANTS MUST AGREE TO PROPERLY MAINTAIN THE PROCHARGER, AND PROVIDE PROOF OF COMPLIANCE WITH THE FOLLOWING REQUIRED MAINTENANCE:**
 - Only ATI supplied oil must be used in the ProCharger.
 - ProCharger oil level must always remain within the specified limits.
 - ProCharger oil change every 100 hours using the ATI supplied oil. (After initial oil change at 15 hours)
 - See special notes on SC applications page.

PROCHARGER® SC EXTENDED COVERAGE PROGRAM REGISTRATION FORM

(MUST BE RETURNED WITHIN 30 DAYS OF PURCHASE WITH \$49 CHECK)

Name: _____

Date of Purchase: _____

Address: _____

Purchased From: _____

City: _____

ProCharger Serial #: _____

State: _____ Zip: _____

Boat Year: _____

Daytime Phone: _____

Boat Make: _____

Evening Phone: _____

Boat Model: _____

Which information sources most influenced your decision to purchase a ProCharger system? Please rank in order of importance (1 = most important, 2 = second most important, etc.).

- Magazine advertising
- Dealer recommendation
- ProCharger Brochures
- Witnessed performance on a car
- Test drive
- Magazine editorials
- Friends
- Conversations with ATI technicians
- Web Site (please specify) _____
- Other (please specify) _____

What magazines do you read?

- Boating
- Family & Performance Boating
- Hot Boat
- Power & MotorYacht
- PowerBoat
- Sport Truck
- Street Truck
- Trailer Boats
- Truckin'
- Truck Trends

What issues most influenced your decision to purchase a ProCharger system? Please rank the following issues in order of importance.

- Reliability
- Standard warranty
- Extended coverage warranty
- Performance
- Quiet operation
- Removability (ability to return car to stock)
- Cost
- Ease of installation

(Optional)
Age 18 - 24 25 - 34 35 - 44
 45 - 54 55 and up

(Optional)
Income \$15,000 - \$29,000 \$30,000 - \$44,000
 \$45,000 - \$69,000 \$70,000 - \$99,000
 \$100,000 and up

Who installed your ProCharger system? Dealer Self Other

Have you owned a forced induction system previously? Yes No

Supercharger: Brand(s) _____ Vehicle(s) _____
Turbocharger: Brand(s) _____ Vehicle(s) _____

I have read and understand the terms and qualifications for the ProCharger Extended Coverage Program. I have not modified my ProCharger in any way and will not during my participation in the extended coverage program. I have read and answered all questions on this form. I have also enclosed my check for \$49, payable to ATI, for enrolling my ProCharger (serial # indicated above) in the extended coverage program for an additional 24 months beyond the standard limited warranty period of 12 months.

Signature: _____ Date: _____

Please mail completed registration form to ATI at: 14801 West 114th Terrace, Lenexa, KS 66215.

If you have any questions, please contact us at (913) 338-3086 9:00-5:00 CST, Monday - Friday
Or, contact technical services via email at techserv@procharger.com

cut along dotted line

cut along dotted line

